

5025

Dual Shelford Microphone Preamplifier

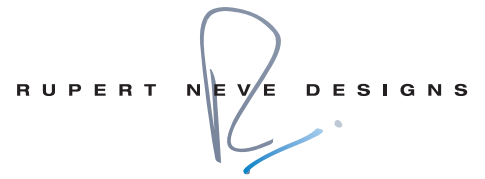

Operations Manual

Important Safety Instructions

1. Read these instructions.
2. Keep these instructions.
3. Heed all warnings.
4. Follow all instructions.
5. Do not use this apparatus near water.
6. Clean only with a dry cloth.
7. Do not block any ventilation openings. Install in accordance with the manufacturer's instructions.
8. Do not install near any heat sources such as radiators, heat registers, stoves, or other apparatus (including amplifiers) that produce heat.
9. Do not defeat the safety purpose of the polarized or grounding-type plug. A polarized plug has two blades with one wider than the other. A grounding-type plug has two blades and a third grounding prong. The wide blade or the third prong are provided for your safety. If the provided plug does not fit into your outlet, consult an electrician for replacement of the obsolete outlet.
10. Protect the power cord from being walked on or pinched particularly at plugs, convenience receptacles, and the point where they exit from the apparatus.
11. Only use attachments/accessories specified by the manufacturer.
12. Use only with a cart, stand, tripod, bracket, or table specified by the manufacturer, or sold with the apparatus. When a cart is used, use caution when moving the cart/apparatus combination to avoid injury from tip-over.
13. Unplug this apparatus during lightning storms or when unused for long periods of time.
14. Refer all servicing to qualified service personnel. Servicing is required when the apparatus has been damaged in any way, such as power-supply cord or plug is damaged, liquid has been spilled or objects have fallen into the apparatus, the apparatus has been exposed to rain or moisture, does not operate normally, or has been dropped.
15. This apparatus shall not be exposed to dripping or splashing, and no object filled with liquids, such as vases or beer glasses, shall be placed on the apparatus.
16. Do not overload wall outlets and extension cords as this can result in a risk of fire or electric shock.
17. This apparatus has been designed with Class-I construction and must be connected to a mains socket outlet with a protective earthing connection (the third grounding prong).
18. This apparatus has been equipped with a rocker-style AC mains power switch. This switch is located on the rear panel and should remain readily accessible to the user.
19. The MAINS plug or an appliance coupler is used as the disconnect device, so the disconnect device shall remain readily operable.



20. NOTE: This equipment has been tested and found to comply with the limits for a Class B digital device, pursuant to part 15 of the FCC Rules. These limits are designed to provide reasonable protection against harmful interference in a residential installation. This equipment generates, uses, and can radiate radio frequency energy and, if not installed and used in accordance with the instructions, may cause harmful interference to radio communications. However, there is no guarantee that interference will not occur in a particular installation. If this equipment does cause harmful interference to radio or television reception, which can be determined by turning the equipment off and on, the user is encouraged to try to correct the interference by one or more of the following measures:

- Reorient or relocate the receiving antenna.
- Increase the separation between the equipment and the receiver.
- Connect the equipment into an outlet on a circuit different from that to which the receiver is connected.
- Consult the dealer or an experienced radio/TV technician for help.

CAUTION: Changes or modifications to this device not expressly approved by Rupert Neve Designs LLC, could void the user's authority to operate the equipment under FCC rules.

21. This apparatus does not exceed the Class A/Class B (whichever is applicable) limits for radio noise emissions from digital apparatus as set out in the radio interference regulations of the Canadian Department of Communications.

ATTENTION — *Le présent appareil numérique n'émet pas de bruits radioélectriques dépassant les limites applicables aux appareils numériques de class A/de class B (selon le cas) prescrites dans le règlement sur le brouillage radioélectrique édicté par les ministere des communications du Canada.*

22. Exposure to extremely high noise levels may cause permanent hearing loss. Individuals vary considerably in susceptibility to noise-induced hearing loss, but nearly everyone will lose some hearing if exposed to sufficiently intense noise for a period of time. The U.S. Government's Occupational Safety and Health Administration (OSHA) has specified the permissible noise level exposures shown in the following chart. According to OSHA, any exposure in excess of these permissible limits could result in some hearing loss. To ensure against potentially dangerous exposure to high sound pressure levels, it is recommended that all persons exposed to equipment capable of producing high sound pressure levels use hearing protectors while the equipment is in operation. Ear plugs or protectors in the ear canals or over the ears must be worn when operating the equipment in order to prevent permanent hearing loss if exposure is in excess of the limits set forth here:



The lightning flash with arrowhead symbol within an equilateral triangle is intended to alert the user to the presence of uninsulated "dangerous voltage" within the product's enclosure, that may be of sufficient magnitude to constitute a risk of electric shock to persons.
Le symbole éclair avec point de flèche à l'intérieur d'un triangle équilatéral est utilisé pour alerter l'utilisateur de la présence à l'intérieur du coffret de "voltage dangereux" non isolé d'ampleur suffisante pour constituer un risque d'électrocution.

The exclamation point within an equilateral triangle is intended to alert the user of the presence of important operating and maintenance (servicing) instructions in the literature accompanying the appliance.
Le point d'exclamation à l'intérieur d'un triangle équilatéral est employé pour alerter les utilisateurs de la présence d'instructions importantes pour le fonctionnement et l'entretien (service) dans le livret d'instruction accompagnant l'appareil.

Duration, per day in hours	Sound Level dBA, Slow Response	Typical Example
8	90	Duo in small club
6	92	
4	95	Subway Train
3	97	
2	100	Typical music via head phones
1.5	102	
1	105	Siren at 10 m distance
0.5	110	
0.25 or less	115	Loudest parts at a rock concert

WARNING — To reduce the risk of fire or electric shock, do not expose this apparatus to rain or moisture.

Table of Contents

Introduction	1
Block Diagram	1
Front Panel	2
Rear Panel	3
5025 Features	4
Specifications	6
Limited Warranty	7







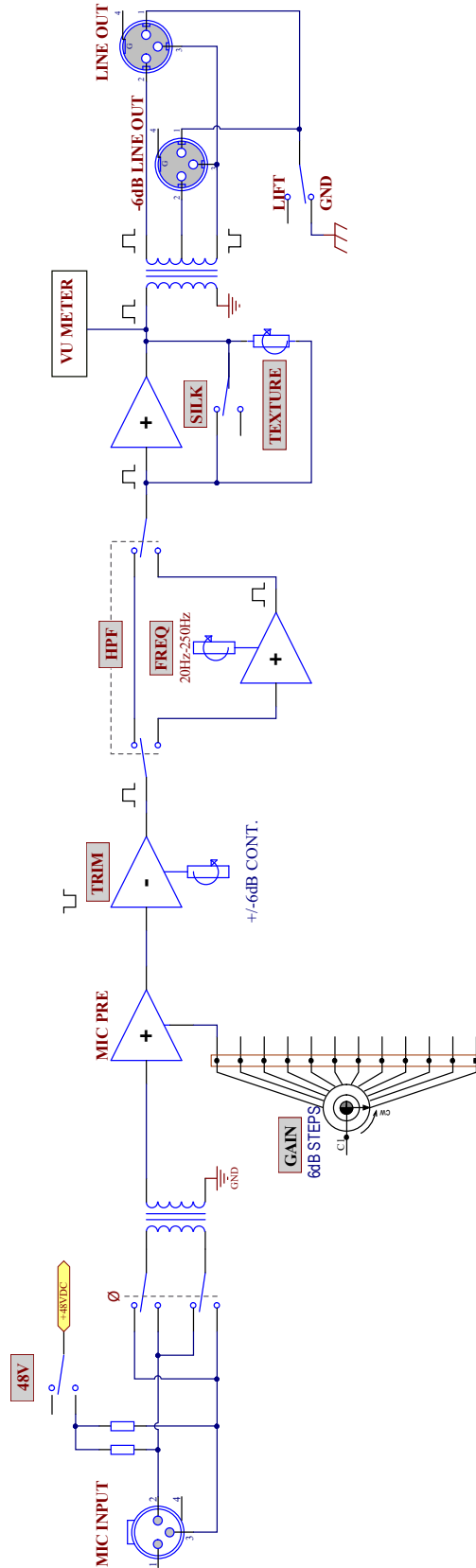

Rupert Neve Designs 5025: Dual Shelford Microphone Preamp

Thank you for purchasing the Rupert Neve Designs 5025. We hope you enjoy using this product as much as we have enjoyed designing and building it. The 5025 features two channels of custom Rupert Neve Designs Transformer Microphone Preamplifier, custom Rupert Neve Designs output transformers with SILK, Class-A analog signal paths, and a variable Sallen-Key High-Pass Filter.

5025 Block Diagram

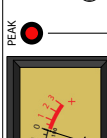

5025 Front Panel

<p>48V Illuminated push-button switch that engages +48V Phantom Power</p>		<p>HPF Illuminated push-button switch that engages the 12dB/octave Sallen-Key High-Pass Filter</p>		<p>VU Meter VU meter that indicates channel output signal level. 0VU=+4dBu</p>		<p>Ø Illuminated push-button switch that inverts the polarity of the input signal</p>		<p>SILK Illuminated push-button switch that toggles through the available SILK modes: OFF, RED, BLUE</p>		<p>GAIN 12-position rotary switch that adjusts the microphone preamp gain from 0 to +66dB in 6dB steps</p>	<p>FREQ 31-detent potentiometer that allows the user to adjust the High-Pass Filter corner frequency from 20Hz to 250Hz</p>	<p>PEAK Peak LED that illuminates when the output signal level has reached -3dB below clip point</p>	<p>TRIM 31-detent potentiometer that adjusts the gain of the input signal within a range of +/- 6dB</p>	<p>TEXTURE 31-detent potentiometer that allows the user to adjust the level of transformer harmonics added within the output stage</p>
<p>48V Illuminated push-button switch that engages +48V Phantom Power</p>		<p>HPF Illuminated push-button switch that engages the 12dB/octave Sallen-Key High-Pass Filter</p>		<p>VU Meter VU meter that indicates channel output signal level. 0VU=+4dBu</p>		<p>Ø Illuminated push-button switch that inverts the polarity of the input signal</p>		<p>SILK Illuminated push-button switch that toggles through the available SILK modes: OFF, RED, BLUE</p>		<p>GAIN 12-position rotary switch that adjusts the microphone preamp gain from 0 to +66dB in 6dB steps</p>	<p>FREQ 31-detent potentiometer that allows the user to adjust the High-Pass Filter corner frequency from 20Hz to 250Hz</p>	<p>PEAK Peak LED that illuminates when the output signal level has reached -3dB below clip point</p>	<p>TRIM 31-detent potentiometer that adjusts the gain of the input signal within a range of +/- 6dB</p>	<p>TEXTURE 31-detent potentiometer that allows the user to adjust the level of transformer harmonics added within the output stage</p>

5025 Rear Panel

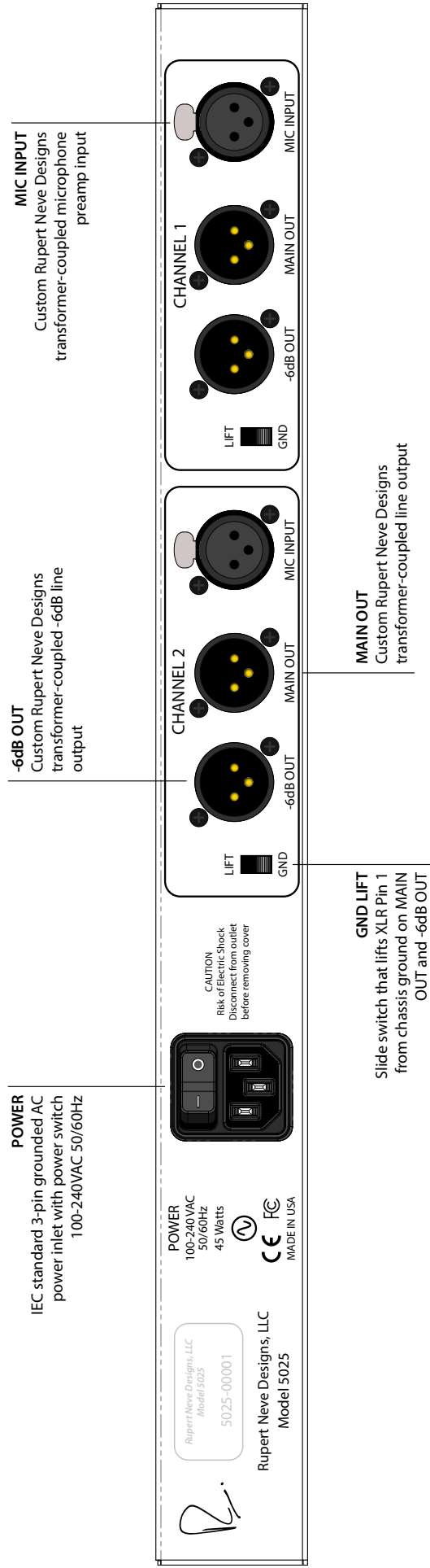

5025 Front-Panel Features

48V

This illuminated push-button switch toggles +48V phantom power ON and OFF.

Ø

This illuminated push-button switch inverts the polarity of the input signal.

High Pass Filter

This illuminated push-button switch engages the 12db/octave Sallen-Key high-pass filter.

Frequency

This 31-detent potentiometer allows the user to adjust the corner frequency of the High-Pass Filter within a range of 20Hz to 250Hz.

SILK

This illuminated push-button switch toggles through three available modes: OFF, RED, and BLUE SILK. Red Silk has a high-frequency pre-emphasis, while Blue Silk has a low frequency pre-emphasis.

Texture

This 31-detent potentiometer allows the user to adjust the amount of SILK harmonics added to the custom Rupert Neve Designs transformer output stage.

Gain

This 12-position rotary switch allows the user to adjust the microphone pre-amplifier gain from 0 to +66dB in 6dB steps.

Trim

This 31-detent potentiometer allows the user to adjust the gain of the input signal within a range of +/- 6dB.

VU Meter

This illuminated VU meter indicates the output signal level for it's corresponding channel. 0VU = +4dBu

Peak

This front panel LED illuminates red to indicate when the output signal level is 3dB below clip point to warn the user that they are approaching clipping.

VU Meter Endstop Adjust

Important: The recessed black adjuster below the VU meters come factory trimmed and should not need any further adjustment. These adjusters allow for VU meter needle bottom endstop calibration (one tick mark below -20VU).

5025 Rear-Panel Features

Power

IEC standard 3-pin grounded AC power inlet with power switch. 100-240VAC 50/60Hz input range with a maximum AC power consumption of 45W.

Ground Lift

This slide switch can be used to help eliminate a ground loop in a studio environment, if encountered. In the LIFT position, XLR Pin 1 on MAIN OUT and -6dB OUT is disconnected from chassis ground. Each channel has its own separate ground lift.

Main Out

Neutrik XLR jack line output utilizing custom Rupert Neve Designs transformer-coupled, balanced output. Maximum output signal level is +26.7dBu at 1kHz.

-6dB Out

Neutrik XLR jack line output utilizing custom Rupert Neve Designs transformer-coupled, balanced output. Maximum output signal level is +20.7dBu at 1kHz.

Mic In

Neutrik XLR jack microphone input utilizing custom Rupert Neve Designs transformer-coupled, balanced input. Maximum input signal level is +24.9dBu at 1kHz.

5025 Specifications

All specifications are typical

$Z_{SOURCE} = 150 \Omega$ Balanced, 30 ft. XLR cable on specified output

Input Impedance	2.2 k Ω
Maximum Input Level @ 1 kHz	+24.9 dBu
Maximum Output Level @ 1 kHz (Main Out)	+26.7 dBu
Maximum Output Level @ 1 kHz (-6dB Out)	+20.7 dBu
Frequency Response	
20 Hz to 20 kHz	+/- 0.25 dB
10 Hz to 62 kHz	+/- 0.5 dB
5 Hz	<< -3 dB
70 kHz	-3 dB
THD+N% (BW 10Hz - 90kHz)	
0dBu Input, 1kHz	< 0.0025 %
+20dBu Input, 1kHz	< 0.008 %
Noise at Main Output (BW 22Hz - 22kHz)	
0dB Gain	-102 dBu
+30dB Gain	-94 dBu
+66dB Gain	-61 dBu
EIN (+66dB Gain)	-127 dBu
Noise at -6dB Output (BW 22Hz - 22kHz)	
0dB Gain	-107 dBu
+30dB Gain	-100 dBu
+66dB Gain	-67 dBu
EIN (+66dB Gain)	-133 dBu
Product Dimensions (W x D x H)	19" (48.3 cm) x 9.2" (23.4 cm) x 1.75" (4.4 cm)
Shipping Dimensions (L x W x H)	24" (61 cm) x 13" (33 cm) x 4" (10.2 cm)
Shipping Weight	11 lbs. (5 kg)

PRODUCT WARRANTY

Rupert Neve Designs warrants this product to be free from defects in materials and workmanship for a period of three (3) years from date of purchase, and agrees to remedy any defect identified within such three year period by, at our option, repairing or replacing the product.

LIMITATIONS AND EXCLUSIONS

This warranty, and any other express or implied warranty, does not apply to any product which has been improperly installed, subjected to usage for which the product was not designed, misused or abused, damaged during shipping, damaged by any dry cell battery, or which has been altered or modified in any way. This warranty is extended to the original end user purchaser only. A purchase receipt or other satisfactory proof of date of original purchase is required before any warranty service will be performed. THIS EXPRESS, LIMITED WARRANTY IS IN LIEU OF ALL OTHER WARRANTIES, EXPRESS OR IMPLIED, TO THE EXTENT ALLOWED UNDER APPLICABLE STATE LAW. IN NO EVENT SHALL RUPERT NEVE DESIGNS BE LIABLE FOR ANY SPECIAL, INCIDENTAL, OR CONSEQUENTIAL DAMAGES RESULTING FROM THE USE OF THIS PRODUCT. Some states do not allow the exclusion or limitation of consequential damages or limitations on how long an implied warranty lasts, so this exclusion may not apply to you.

WARRANTY SERVICE

If you suspect a defect in this product, please call us at 512-847-3013 or contact our support staff (service@rupertneve.com) for troubleshooting. If it is determined that the device is malfunctioning, we will issue a Return Material Authorization and provide instructions for shipping the device to our service department.



Rupert Neve Designs

PO Box 1969

Wimberley TX 78676

www.rupertneve.com

tel: +1 512-847-3013

fax: +1 512-847-8869