



Royer Labs

Model SF-24

Stereo Active Ribbon Velocity Microphone

Operation Instructions Manual
& User Guide

Made in U.S.A.

SF-24

TABLE OF CONTENTS
Model SF-24 Ribbon Microphone
Revised 2019

Introduction	3
Active Ribbon Technology	3
Description	4
Applications	5
Ribbons in the Digital World	5
User Guide	6
<i>Using the SF-24 Active Ribbon Microphone</i>	6
Operation	7
Amplification Considerations	8
Stereo Microphones and Ground Loops	9
<i>Equalization and Ribbon Microphones</i>	9
<i>Hum, Noise and Mic Orientation</i>	10
Microphone Techniques	11
<i>General Tips for Using the Royer SF-24</i>	11
Specialized Stereo Recording Techniques	13
<i>Classic Blumlein Technique</i>	13
<i>Mid-Side (M-S) Technique</i>	14
Care and Maintenance	15
<i>Care for the Optical Black Finish</i>	16
Features	16
Specifications	17
Wiring Diagram	18
Polar Pattern	18
Frequency Response	18
Warranty	19

Introduction

Congratulations on your purchase of a Royer Labs model SF-24 stereo active ribbon microphone. The SF-24 is a handcrafted precision instrument capable of delivering superior sound quality and exceptional performance. The SF-24 represents a new level of performance for ribbon microphones, combining sophisticated technological advancements with old-world craftsmanship. The SF-24 incorporates two independent head amplification systems that operate on standard 48-volt phantom power, similar to standard condenser microphones. This enables the SF-24 to deliver the same sensitivity that the recording industry has grown accustomed to with modern condenser microphones. In addition, the active circuitry completely isolates the ribbon element from impedance mismatches, short circuits and other anomalies that can degrade microphone performance or damage the sensitive ribbon element. The SF-24 breaks the long-standing taboo associated with ribbon microphones and phantom power; it actually requires phantom power to operate.

This instruction manual describes the SF-24, its function and method of use. It also describes the care and maintenance required to ensure proper operation and long service life. The User Guide section of this manual offers practical information designed to maximize the performance capabilities of this microphone.

Royer Labs products are manufactured to the highest industrial standards using only the finest materials obtainable. Your model SF-24 went through extensive quality control checks before leaving the factory. Normal care is all that is required to assure a lifetime of trouble-free service.

Please read this manual thoroughly in order to become familiar with all of the SF-24's capabilities. It will assist you in making the most of your microphones' superior acoustic properties. This manual is a handy reference guide and we suggest you refer to it whenever questions arise on the use and care of your SF-24 ribbon microphone.

Active Ribbon Technology

The heart of the SF-24 is its proprietary electronic system consisting of specially designed toroidal transformers and electronic buffering stages. This system provides excellent frequency response, extremely low noise and distortion, and high SPL handling (130 dB) without the use of pads. It gives the SF-24 an output level comparable to that of condenser microphones, and its buffer stages provide a low impedance output *and* present a perfect impedance load to each of the ribbon elements. Unpowered ribbon microphones suffer substantially degraded frequency response and lowered gain when they are paired to a preamp with too low an input impedance. With the SF-24's active electronic system, the microphone's frequency response and output are much less affected by variations in the input impedance of the following preamp.

Sonically the SF-24 differs from the unpowered SF-12 in one subtle way; due to the extra iron in the SF-24's much larger transformers, low-end frequencies sound slightly tighter and more focused.

Key Points:

- No longer is it necessary to mate a ribbon microphone to an ultra-high gain, low noise preamplifier for optimum performance. Any preamplifier of nominal gain will provide good results with the SF-24.
- No longer is it necessary to carefully consider impedance matching characteristics when choosing a preamplifier. Microphone loading is a non-issue and consistent performance is assured, regardless of the preamplifier's impedance characteristics.
- No longer is it necessary to be concerned about damaging the ribbon element with phantom power. The active electronics *need* phantom power to operate - a first for ribbon microphones.
- No longer is it necessary to worry about the effects of long cable runs degrading the performance of your ribbon microphone. The active electronics provide a robust low impedance signal that can handle long cable lengths with minimal loss of signal.

Description

The SF-24 stereo coincident active ribbon microphone is the only microphone of its kind available, combining high audio performance with outstanding separation and imaging. It is a modern ribbon design, with no audible diffraction effects or cavity resonance. The SF-24's active electronics produce an output comparable to phantom powered studio condenser microphones and because the ribbon elements are electronically isolated from the outside world, the possibility of ribbons becoming damaged as a result of faulty wiring, brownouts or phantom power supply defects is virtually eliminated.

The SF-24 is a compact, stereophonic ribbon microphone array consisting of two matched microphone elements that are placed one above the other. Each transducer is positioned at 45 degrees to the left and right of center, or 90 degrees from each other. When held vertically, connector down and the "ROYER" logo facing the sound source, the upper element is the *right* channel and the lower element is the *left* channel, from the perspective of an observer behind the mic. The microphone elements are each bidirectional (figure-8) and may be addressed from either side with equal sensitivity. The in-phase signals are achieved when the microphone is addressed from the front, as indicated by the "ROYER" logo. If, however, the microphone is suspended upside down, the connections to the preamplifier should be reversed since what was the left transducer is now responding to signals from the right and vice versa.

Your SF-24 is equipped with a 5-pin XLR type extension cable and a splitter cable that fans out to twin 3-pin male XLR connectors. As shipped from the factory, the connectors are marked "upper" and "lower," since referring to them as "left" and "right" could lead to confusion.

The SF-24 is reasonably tolerant of shock and vibration, but care should be taken to prevent accidental stretching of the ribbon elements. This is covered in the *Care & Maintenance* section of this manual. The performance of the microphone is unaffected by changes in temperature or humidity.

Applications

The SF-24 is a highly versatile microphone, ideally suited for a wide range of critical recording applications. From drums, acoustic stringed instruments and stereo vocals to ensembles like big band, orchestra and jazz groups, your SF-24 will capture performances with uncanny realism and a beautifully full stereo image.

Because of the SF-24's coincident crossed figure-8 pattern, M-S (mid-side) recording from one microphone is easily achievable. Once a recording has been completed using the proper orientation, the sound field can be adjusted from pure monophonic to "super wide."

Although spaced microphones can produce similar stereophonic results, such recordings when summed to mono can suffer from "comb filter" effects: peaks and dips in the frequency response. When the SF-24 is used for M-S recording, the feeling of space changes but the sonic quality does not. For more detailed information on the M-S technique, see the chapter Recording Techniques: Mid-Side (M-S) Recording in this manual.

The SF-24's small size and optical black chromium finish create minimal disturbance in the visual field, which is especially important when the microphone must not obstruct the view of an audience or of a motion picture or TV camera.

Ribbons in the Digital World

Digital recordings benefit greatly from the properties inherent in ribbon microphones. Since A to D converters cannot distinguish between the sound source being recorded and the complex distortion components often associated with condenser microphones, they sometimes have difficulty tracking the signal, resulting in ringing and edgy-sounding tracks. With ribbon microphones, ringing is almost nonexistent due to the ribbon's lack of distortion artifacts and high frequency peaks. A to D converters have less difficulty tracking the ribbon generated signal, resulting in very smooth digital recordings free of microphone-related edginess.

User Guide

Using the SF-24 Active Ribbon Microphone

The head amplification system utilized in the SF-24 was designed to operate with standard 48 volt simplex phantom power sources only. The microphone will not work at all if ***phantom power is not provided to the microphone!*** This aspect of an active ribbon microphone is in sharp contrast to the common wisdom normally applied to ribbon microphones, in which phantom power usually spells danger or destruction to the ribbon element. Royer's active series ribbon microphones require phantom power to operate.

To ensure long service life of your SF-24 active ribbon microphone, care should be taken when connecting the microphone to a phantom power source. We have prepared a few tips to ensure that your SF-24 will perform perfectly for many years. We offer the following information as a general set of good habits that apply to both active ribbon mics and solid-state condenser microphones as well.

1. Always be certain to use the SF-24's five-lead stereo cable, which splits out to two short 3-pin cables with male XLR connectors labeled "Upper" and "Lower." Do not substitute extension cables of unknown wiring! The SF-24's pin-out is Pin-1 shared ground for both ribbon transducers, Pin-2 signal hot (in-phase) for the upper transducer, Pin-3 signal cold (reverse phase) for the upper transducer, Pin-4 signal hot for the lower transducer, Pin-5 signal cold for the lower transducer. If additional extension cables are used, be sure they are in good serviceable order. Standard microphone cables provide a shielded ground carried along to Pin-1 and a balanced differential signal carried along Pins-2 and 3, with Pin-2 signal hot and Pin-3 signal cold.
2. Although it is usually safe to "hot plug" most phantom powered microphones to a preamplifier or console with the phantom activated, we suggest that if it is possible to deactivate the phantom power prior to plugging in the microphone, do so. This minimizes any chance of random voltage surges entering the microphone. More importantly, it reduces the possibility of loud pops being transmitted to your monitor speakers should the volume control be raised. Serious damage to your speakers could result from this mistake.
3. Be certain that the input channel fader or volume control is set to minimum before plugging in any microphone. Preamplifier gain trim should be set to minimum. Plug the microphone in and activate the phantom power switch. The microphone's electronics will stabilize in a few seconds.
4. When the microphone becomes operational, bring the two channel faders to 0-dB (unity) and use the trims to set the desired level. This technique maximizes the signal-to-noise performance of the preamplifier or console input channel.
5. When disconnecting the microphone, bring the channel faders down and unplug the microphone cable ends. It is also advisable to turn off the phantom power before unplugging the microphone whenever possible.

6. If the studio has the microphone lines brought to a patch bay (tie lines), never crosspatch a microphone line when phantom power is applied or the monitor volume is raised. This could cause damage to your microphone, preamplifier or monitor speakers.

Operation

There are a few important facts that are key to understanding how to use ribbon microphones successfully.

1. With ribbon microphones, rejection in the “dead” areas is very strong. Due to this directionality, ribbon mics should be placed at 1.3 times the distance normally used with omni-directional microphones, or at approximately the same distance used for cardioid microphones. This method is used to achieve the same ratio of direct to reflected sound.
2. In the horizontal plane, ribbon microphones do not discriminate against the “highs” off axis, nor do they boost them on axis. Therefore, several instruments or vocalists can be placed in front of the microphone without favoring the performer in the center of the group.

Several performers can be grouped at both the front and the back of the microphone, with one proviso: Since the outputs are out of phase at the front and back of the microphone, cancellation can result if two tenors are placed on opposite sides at equal distances and are singing in unison. Therefore, listen to the feed before committing to it.

3. The Royer model SF-24 is a phantom powered microphone and must be connected to a preamplifier or console cable of delivering 48-volts at a minimum of 4-milliamperes per channel. Faulty or improperly wired cables could cause your SF-24 to become inoperative. Since the active electronics offer electrical isolation to each ribbon, miswired cables should not cause damage to the ribbons themselves.
4. Never attempt to “test” the SF-24 (or any ribbon microphone) with an ohmmeter. Damage to the delicate electronics could occur.

Always provide adequate protection for your SF-24 (or any ribbon microphone). If the microphone is to remain set up on a stand when not in use, place a “mic sock” (provided) over it until it is to be used. As even light wind can stretch the SF-24’s ribbon elements, do not carry the microphone around without placing a mic sock over it. Failure to follow this commonsense practice may yield a stretched ribbon and compromised performance!

5. Avoid dropping the microphone. An accidental fall to a hard surface could stretch one or both ribbons and, depending on the nature of the fall, possibly require a complete overhaul of the microphone.

Amplification Considerations

Almost any stereo microphone preamplifier (or pair of mono preamplifiers) with nominal gain characteristics and built in 48-volt phantom power sources will give excellent results with your SF-24 active ribbon microphone. Unlike standard ribbon microphones, which depend on a proper impedance match to deliver optimal performance, the input impedance of your preamplifiers will have minimal affect on the SF-24's performance because the ribbon elements are loaded perfectly via the microphones' internal electronics.

Careful consideration should be given to the *quality* of the microphone preamplifier. Studio grade preamplifiers usually sound much better than cheaper ones. Headroom, noise floor, transparency and coloration are all factors to consider in determining which preamplifier is suitable for your studio or live applications. Other features are usually secondary and fall into the category of conveniences or interface capabilities (such as digital or optical outputs).

A good preamplifier should sound natural, with no sign of edginess or excessive noise. Vacuum tube preamplifiers sound warm, yet wonderfully airy and transparent. Do not expect a vacuum tube preamplifier to be as quiet as a solid-state preamp, as electron emissions from tubes tend to convey more "thermal" noise than transistors. Tube preamplifier noise is far less of an issue with the SF-24 than with conventional ribbon microphones because the SF-24's high output will override the noise. Transformer coupled designs tend to sound punchy and full bodied and offer the added benefit of true electronic isolation. This greatly enhances their ability to interface with other equipment with minimal noise or hum. There are many excellent preamplifiers on the market today. Choose one that fits your budget and offers good performance, but remember that you get what you pay for. If you have the opportunity to audition one or more preamplifiers before you buy one, do so. Microphones and preamplifiers work together as a team and some are just better matches than others.

The SF-24 is capable of substantial output signal, especially when used for high SPL applications like drum overheads. It will not overload or produce distortion up to its SPL handling capacity of 130 dB SPL. In actuality, the SF-24's ribbons would stretch well before its electronics would reach an overload condition. Due to the high output potential of the SF-24, it is recommended that the microphone preamplifier you pair it with have a switchable pad to prevent the possibility of overloading the preamplifier's input stage electronics. Some preamplifiers are more thoughtfully designed than others, with a suitable pad that is placed *before* the preamp's active electronics, not incorporated into a "feedback loop" as is sometimes found. The latter design could still produce distortion due to overloading even if the pad were used. Although this is rarely an issue, we felt that it was important to cover the subject.

In conclusion, preamplifier coloration is optional and a matter of personal taste. Some people love the effect of coloration while others strive for absolute transparency.

Stereo Microphones and Ground Loops

Some preamplifiers are prone to developing ground loops when used in conjunction with stereo microphones such as the SF-24. Ground loops can develop in the preamplifier with any stereo microphone regardless of type (i.e. condenser, dynamic, ribbon). A ground loop manifests itself as unwanted buzz or hum at 60 Hz and/or harmonics of 60 Hz.

The condition is brought on when the left and right transducer elements are plugged into two inputs of a stereo or multi-channel preamplifier. The two three-pin male XLR connectors of the stereo microphone cable usually share Pin-1 as ground, so they are grounded to each other through the cable set. If the grounding scheme within the preamplifier is poorly designed, or the distances to internal ground are too great, a ground loop develops.

You can perform a simple test to check for this condition (preferably done with a pair of headphones to avoid feedback). Plug one side of the stereo microphone into either preamplifier input. Listen to the output of the preamp. All should be quiet except for the mic signal. Now plug the second side into the next preamplifier input. If a noise or buzz develops, you have a ground loop. The ground loop may be very slight or more pronounced, depending on the preamp. Battery powered preamps usually do not exhibit this problem, and neither do well designed, line-operated mic preamps. The simple fix is to disconnect one of the microphone's two Pin-1 ground connections. A better method is to make a small ground-lift adapter fashioned from a male-female XLR barrel adapter. Switchcraft makes a very nice one and it takes less than five minutes to wire it up. Simply connect Pin-2 to Pin-2, Pin-3 to Pin-3, and leave Pin-1 disconnected. Correcting the problem at the preamplifier is preferable, but is often more difficult and/or expensive.

Equalization and Ribbon Microphones

One of the great strengths of ribbon microphones is how well they take EQ. Even with substantial amounts of equalization, ribbons retain their natural, "real" quality. For example, when a lead vocal is being performed on a ribbon microphone, you can boost the upper-end frequencies to the point where the ribbon mic emulates the performance curve of a condenser mic with excellent results. This is not to say that a ribbon microphone can replace a quality condenser mic, but the EQ friendliness inherent in ribbon microphones does allow for an enormous amount of flexibility.

The reason that ribbon mics take EQ so well is their inherent low self-noise, unusually smooth frequency response characteristics and freedom from off-axis coloration. Dialing in high amounts of equalization on condenser or dynamic microphones also means dialing in extra amounts of the microphone's distortion products and self noise contributing to an unnatural, unpleasant sound. Because distortion and self-noise are almost nonexistent in ribbon microphones, high levels of EQ can be used without adding harshness or excessive noise.

Hum, Noise and Mic Orientation

All dynamic microphones, including ribbons, are susceptible to picking up stray alternating magnetic fields. Power transformers (such as those found in guitar amplifiers) and alternating current motors are the most likely sources of hum. In-wall wiring and electrical utility transformers are other likely sources. A well-designed microphone provides shielding to minimize the effects of such stray magnetic radiation. In some cases complete isolation is impossible and the result is usually hum or buzz. Unpowered ribbon microphones can manifest this condition to a greater degree because of their higher gain requirements. With vintage ribbon microphones that often employ large, bulky magnet structures and are often poorly shielded, the problem can be worse.

The SF-24 reduces this condition because the essential gain is provided at the microphone, negating the need for additional gain to be supplied by the preamplifier. In addition, the Royer SF-1, SF-12 and SF-24 family of microphones are designed to minimize the effects of unwanted radiation by integrating the transducer barrel as part of the magnetic return circuit. Royer's SF-series ribbon microphones go one step further by incorporating toroidal impedance matching transformers, which have a natural ability to repel magnetic radiation.

Unwanted noise (hum) can only come from external sources. Fortunately, simply repositioning a ribbon microphone is the best way to get rid of unwanted noise. If hum is detected, the microphone is in the proximity of an alternating magnetic field.

While listening (preferably with headphones) to the mic, move it around. The mic will "find" the noise source quite easily. For example, if you are miking a guitar amplifier and suspect the amplifier's power transformer may be the source of unwanted hum, move the mic around the amp. You will probably find that the hum is louder as you approach the amplifier's power supply and quieter when you move it away. Eliminating the hum can be fairly simple and requires finding the "null" point of the hum. The "null" point is the position that places the microphone's magnetic components away from the lines of the noise's radiation. Slightly rotating the microphone is usually all that is required to cancel out the hum. This is similar to the procedure guitarists use to eliminate hum from single coil guitar pickups: turning around slowly while listening for the hum. There will be a position where the hum disappears completely.

Hum and other noise is often picked up in microphone cables. Since the output of Royer Active Series mics is 15 to 25 dB higher than with traditional ribbon microphones, any noise picked up in the mic cables will be at a corresponding lower level, and hence less likely to be objectionable.

Microphone Techniques

General Tips for Using the Royer SF-24

The following are good basic starting places for recording with the SF-24. These positions are known to produce good results, but experimentation is the key to getting the most out of your recordings! Photographs of many of the following techniques can be found on our website -www.royerlabs.com.

It is important to remember that the SF-24's ribbon elements can be damaged by wind. When the SF-24 is mounted on a boom stand, be sure the stand is moved slowly. When the microphone is taken down, put it in its box immediately or, if it is to remain in its shock mount, place the mic sock over the ribbon end of the microphone. Leaving the microphone out unprotected is inviting a re-ribbon.

Ensemble Performances

The SF-24 records ensemble performances beautifully. Simply find the point in the room where you hear the best blend of the instruments and room sound and place the microphone there, with its logo facing the performers.

Strings

For stereo recordings of stringed instruments, start by positioning the microphone a few feet off the body of the instrument. Depending on the acoustics of the room, you may want to move the microphone closer to or further from the instrument to add or minimize ambience. For violin, position the SF-24 horizontally, two or more feet above the instrument. For larger string sections, try placing the microphone slightly above the instrumentalists and angled down; a distance of three or four feet will do the job nicely.

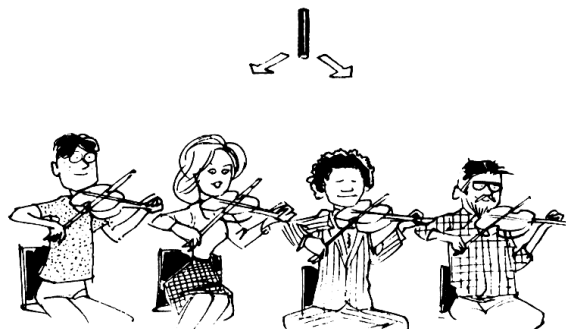

Drum Overhead & Room

Position the SF-24 horizontally over the center point of the kit, two to three feet above the cymbals. For a centered snare drum, aim the Royer logo at the snare. Adjusting the height of the SF-24 by even 6-inch increments will produce dramatic variations in how the cymbals sit with the rest of the kit. Many times an overhead SF-24 is all that is needed for tom-toms and cymbals.

For a single point stereo room mic, position the SF-24 vertically at four to eight feet in front of the kit. Compress to taste for either a very natural drum sound (light compression) or large rock drum sound (heavy compression).

For jazz recordings, EQ is generally not required. For more aggressive drum tracks where cymbals need to sizzle, you can brighten them by adding a few dB of 10 K to 12 K.

Brass

Brass records beautifully with ribbon microphones. For an overall picture of a brass section within a larger recording session, try placing the microphone two to three feet above the instrumentalists and angled down, at a distance of three to eight feet from the section. For a solo brass section, position the SF-24 vertically at a height of four to eight feet and anywhere from five to 20 or more feet from the section.

Close miking brass is a job for the Royer R-121 or R-122 - we do not recommend close-miking with the SF-24.

Reed Instruments

Normal working distances are about a foot or two from a solo reed instrument. For multiple instruments, try placing the microphone slightly above the instrumentalists and angled down, at a distance of two to four feet.

Piano

There are several positions that will give excellent results with the piano. Start with a distance of one foot to several feet from the knee of the piano. A more direct “up front” sound will be achieved when the microphone is placed closer to the soundboard. If it is possible to remove the piano lid, an SF-24 suspended horizontally over the soundboard will give outstanding results. If the room sounds good, try positioning the mic 10 to 20 feet from the piano.

If you position the SF-24 somewhere between the soundboard and the open lid of the piano, there will be some amount of reflected sound from the lid. Careful positioning can minimize or accent lid reflections, depending on what sound you’re striving for.

Choir and Orchestra

An SF-24 can produce dramatically good recordings of an orchestra or choir. If possible, position the SF-24 at a height of ten feet or so and a few feet behind the conductor. The wide stereo pickup will reproduce the orchestra or choir with a stunning you-are-there realism. The rear lobes of the figure-8 elements bring the ambient qualities of the recording environment into the recording, adding to the natural feel of the recorded performance.



Percussion

The SF-24 records percussion instruments naturally, without upper frequency hype or low-end boominess. Congas, bongos and the like can be recorded with left/right stereo effect by positioning the mic within a few feet of the instruments. Shakers, bells, triangles and other instruments that are often problematic in the upper frequencies will record naturally and non-abrasively.

Vocal with Acoustic Guitar

For recording a vocal with acoustic guitar, two separate mono tracks are required with little leakage between the tracks. One stand and one SF-24 can do the job nicely when the two axes of sensitivity are correctly oriented (*see illustration*).



Note:

The SF-24 is not recommended for close-miking loud amplified instruments. Its sensitive ribbon elements were not designed for extremely high SPL applications like close-miked electric guitar. For close-miking high SPL sound sources, ruggedness is a must and we recommend using our R-121 or R-122 ribbon microphones.

Specialized Stereo Recording Techniques

Classic Blumlein Technique

For many years, “coincident” microphone setups have been widely used for picking up sounds in stereo as naturally as possible. The “Blumlein” technique, named for A.D. Blumlein, involves the



use of two figure-eight microphones positioned as in the sketch (*see Figure 1*); so that one faces left and the other faces right, at an angle of 90 degrees (i.e., each displaced 45 degrees from center).

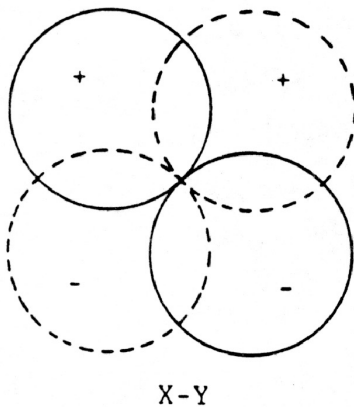

Each microphone ultimately feeds one speaker in a stereo system, and due to the directionality of the microphones, the result is a very well defined stereo image on playback. For classical music, particularly, the reproduction can be very satisfying.

The SF-24 stereo microphone is two identical ribbon microphones in just this Blumlein orientation: if the microphone is placed in front of the performance, with the Royer logo facing the center of the ensemble to be recorded, the microphone will give a stereo recording as per the Blumlein technique. Because of the togetherness of the SF-24's ribbon transducers,

Figure 1

sound will arrive at both ribbon elements at the same time. This means that the two channels can be summed to mono with no comb filter effects, and room reverberation (undesirable in mono) is cancelled to a surprising degree.

For the sake of clarity, engineers commonly refer to similar stereo miking with *cardioid* mics as “X-Y.” When *figure-8*'s are used, it is more commonly referred to as “Blumlein” recording.

Mid-Side (M-S) Technique

In the early days of stereo radio broadcasting, the Mid-Side recording technique was developed to allow for 1) simultaneous stereo and mono feeds from the same mic array and 2) electronic manipulation of the width of the stereo image. In M-S recording, one mic faces sideways, one faces forward as shown in *Figure 2*, and they are connected as shown in *Figure 3*.

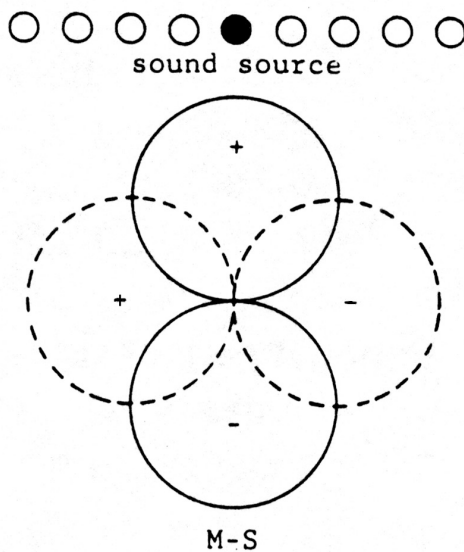

Figure 2

With the SF-24's logo facing the center of the performance, the mic is positioned for X-Y recording. Rotating the SF-24 counter-clockwise by 45¼ positions it for M-S recording.

By inserting your SF-24 with the logo in the left slot of the RSM-24 shock mount (see *Using the RSM-24 Shock Mount*, page 9), then facing the shock mounts logo directly at the center of the performance, the microphone will be rotated 45 degrees counter-clockwise and correctly positioned for M-S recording. With the SF-24 in a vertical position, cable end down, the upper ribbon element faces the center of the performance and is the “mid” microphone, and the lower ribbon element is at 90 degrees to the performance and is the “side” microphone. If the microphone is to be mounted upside down, make the proper adjustments in your wiring orientation.

If the outputs of the mid and side elements are made equal using gain controls, the stereo pickup will be similar to that of two microphones placed as a Blumlein X-Y pair, delivering a wide stereo image. As you reduce the level of the “side” element, the width of the stereo image will narrow until, with the side element turned all the way down, you have just the “mid” element panned center and giving a mono pickup.

If the outputs of the “mid” and “side” elements are recorded on separate tracks, the electrical connections shown in *Figure 3* can be made at the mixer outputs and the adjustment of the stereo separation can be done during mixdown, rather than during the actual recording.

Space does not permit a fuller discussion of the M-S intensity stereo format, first described by Alan D. Blumlein over 50 years ago. We suggest the following reading on the subject:

W. Dooley & R. Streicher
“M-S Stereo: A Powerful Technique for Working in Stereo”
Audio Eng. Soc., Vol. 30 pp.707 (1982 Oct.)

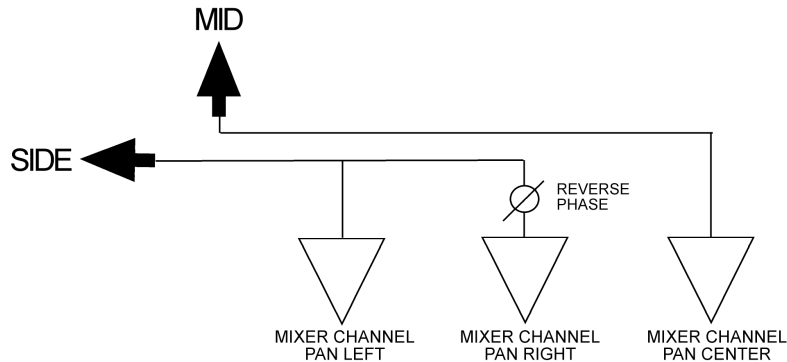

Figure 3

Care and Maintenance

The SF-24 is a solidly built, precision instrument. All that is required to ensure proper operation of this microphone is to follow some commonsense rules.

1. To avoid transducer damage, do not expose the microphone to severe shock or vibration. If the microphone is accidentally dropped, test it to see if damage has occurred before returning it to service. Low output or a dull sound would indicate a stretched ribbon.
2. Do not expose the microphone to direct blasts of air or strong air currents. Use a windscreen or suitable blast filter when close miking a vocalist or certain types of wind instruments. P-popping does not necessarily damage the ribbon element but may produce unacceptable preamplifier overload and could cause damage to speaker systems.
3. Do not expose the microphone to liquids or caustic smoke.
4. Do not expose the microphone to strong alternating electromagnetic fields, i.e. the power transformers in amplifiers, or a hum may result.
5. Use a soft cloth to clean the microphone body. A small amount of denatured alcohol can be used to remove fingerprints and other stains.
6. Keep metal filings away from the microphone at all times. The SF-24's powerful magnets can attract minute ferris particles into the ribbon transducers, compromising the performance.

7. When not in use, store the microphone in its protective carrying case. If the microphone is to remain set up on a mic stand between sessions, cover it with its mic sock (provided with your SF-24).
8. Leave disassembly of the microphone to a trained technician. There are no user-serviceable parts inside.

Care for the Optical Black Finish

The SF-24's optical black finish is a sophisticated surface treatment designed to refract light rather than reflect it. This makes the microphone appear less conspicuous, especially when used with high intensity lighting or within a camera shot. The finish requires occasional maintenance to retain a smooth, even appearance and to maintain its unique optical qualities.

The SF24's body is comprised of a low carbon steel alloy. Its finish consists of black chrome deposited over a nickel substrate, creating a finish that minimizes the reflective nature of the metal surface. A small amount of oil has been worked into the finish at the factory to protect it. Over time, some of this oil will be drawn out due to "wicking" action; the physical handling of the microphone, absorbent materials it is exposed to (like the foam padding of the microphone case), etc. As the oils are drawn out of the microscopic surface layer, the microphone finish may develop an uneven appearance. If this happens, simply massage the microphone gently with a lint free cloth treated with a few drops of light machine oil or WD-40 (apply the oil to the cloth, not to the microphone). Be very careful whenever working around the transducers to avoid contamination of the ribbon elements. Following this simple procedure will protect the finish and renew it to its original luster.

CAUTION!

Due to the transducer's powerful magnets, keep recorded tapes, spring-wound watches and personal credit cards with magnetic coding away from the microphone to prevent possible damage.

Features

- Excellent stereo imaging and separation in one microphone
- Smooth, wide frequency response
- Active electronics offer greatly enhanced output and a constant, optimized impedance to the ribbon element
- X-Y, M-S or mono recording from one microphone
- Extremely low residual noise
- Ribbon elements are unaffected by heat or humidity
- Absence of high-frequency phase distortion
- Excellent phase linearity – even off axis

- Equal sensitivity from front or back of microphone
- Consistent frequency response regardless of distance
- Compact size

Specifications

Acoustic Operating Principle: Electro-dynamic pressure gradient with active electronics

Polar Pattern: Symmetrical Figure-8

Generating Elements: Two 1.8-micron aluminum ribbons

Frequency Response: 30 Hz – 15,000 Hz \pm 3 dB

Sensitivity: $>$ -38 dBv Ref 1 v/pa

Self Noise: $<$ 18 dB

Output Impedance: 300 Ohms @ 1 kHz

Recommended Load Impedance: $>$ 1500 Ohms

Maximum SPL: $>$ 130 dB

Output Connector: Male XLR 5 pin

Power Requirements: 48-Volt Phantom (per channel) only

Supply Current: 4 mA per channel

Dimensions: 270 mm X 39 mm (base) X 25 mm (top) (10 5/8" X 1.5" wide (base) X 1" wide (top))

Weight: 531 grams (18.7 ounces)

Finish: Optical Black Chrome 18K Gold (optional)

Accessories: Protective carrying case, protective mic sock, 25' shielded 5-conductor cable with 5-pin connectors, adapter cable terminating in two (2) XLR 3-pin male connectors, RSM-24 shock mount

Optional Accessories: WS-12 blast filter, 10 dB in-line pads

To learn more about Royer products and their usage, visit our website at www.royerlabs.com.

Wiring Diagram

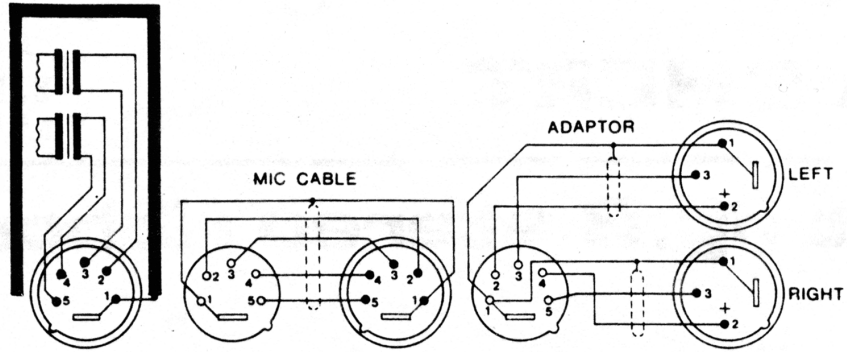

Polar Pattern

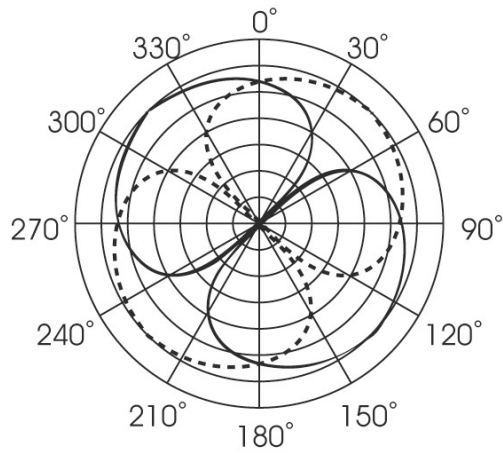

Frequency Response

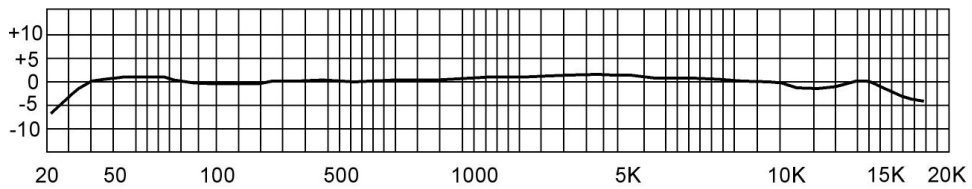

Warranty

PLEASE RETAIN YOUR ORIGINAL BILL OF SALE AS YOU WILL NEED TO PRESENT IT SHOULD YOU REQUIRE SERVICE UNDER THIS WARRANTY.

TO VALIDATE THIS WARRANTY, THE REGISTRATION CARD AND A PHOTOCOPY OF THE SALES RECEIPT FROM AN AUTHORIZED ROYER DEALER MUST BE ON FILE WITH ROYER LABS.

Royer Labs warrants all Royer products sold by Royer Labs' authorized dealers and/or distributors worldwide with the following terms and conditions.

WARRANTY PERIOD

- 10-year full warranty coverage on materials, workmanship, and finishes to the original owner.
- Ribbon Element – First re-ribbon free to the original owner within one year of purchase.
- Extended Ribbon Element policy – First re-ribbon free within five years of purchase if the microphone is registered by the original owner within one year of purchase. *Microphones must be registered within one year of purchase for extended ribbon element warranty coverage.*

SCOPE OF WARRANTY:

From the date of original purchase and for the respective periods specified above, Royer Labs agrees to repair all Royer Labs products which are defective in material and workmanship.

EXCLUSIONS:

This warranty does not apply in the event of the following:

1. Defects or damage caused by accident, fire, flood, lightning or other acts of nature.
2. Defects or damage caused by abuse, misuse, negligence or failure to observe the instructions contained in
3. the owner's manual furnished at the time of original purchase.
4. Products that have been altered or repaired by anyone other than a Royer Labs authorized service facility.
5. This warranty applies to the original owner only and is not transferable.
6. Normal wear and tear of the finish.

OBTAINING WARRANTY SERVICE:

Warranty service is provided by Royer Labs or Royer Labs authorized repair facilities. All products returned for warranty or repair service must be accompanied by a Royer Labs Repair Authorization Form. These forms are available on our website at:

[US Repair Authorization Form – contact Royer for RA number](#)

[Non-US Repair Authorization Form – contact Royer for RA number](#)

The product(s) must be returned in original packaging, or packaged as shown in the Repair & Service section of our website. Royer Labs is not responsible for warranty or service-related shipping charges.

ROYER Labs
2711 Empire Ave.
Burbank, California 91504
Telephone 818.847.0121
www.royerlabs.com