



Radial Engineering Ltd.
1845 Kingsway Ave., Port Coquitlam, BC V3C 1S9, Canada
Tel: 604-942-1001 • Fax: 604-942-1010
Email: info@radialeng.com

JDI[™]

Passive Direct Box User Guide

RADIAL JDI™ USER GUIDE

TABLE OF CONTENTS	PAGE
1. Introduction	1
2. JDI feature set	2
3. JDI quick start	3
4. Direct box basics.....	4
5. Features and functions	7
6. Other cool uses for your JDI	11
7. Frequently asked questions	12
8. Block diagram and specifications.....	15
Warranty.....	Back cover

Part 1 - Introduction

Congratulations on your purchase of the world's finest direct box! The Radial JDI is the latest version of the highly acclaimed JDI and is without a doubt the finest passive direct box available today. The JDI is very unique in that it does not color or alter the sound in any way. This ensures that natural tone and harmonic balance is retained, bringing out the very essence of the instrument.

The JDI employs a Jensen JT-DBE transformer for unmatched audio performance, exceptional noise rejection and high signal handling. This makes it ideal for acoustic guitar, bass and keyboards. In fact, just about any audio signal is transformed gracefully without artifact.

We suggest that you read this manual before using the JDI so that you can maximize its potential. Please log onto the Radial Engineering website at www.radialeng.com for further details and FAQ updates. We invite you to forward any comments, questions or suggestions to info@radialeng.com - we'd love to hear from you.

Enjoy!



Part 2 – The JDI Feature Set

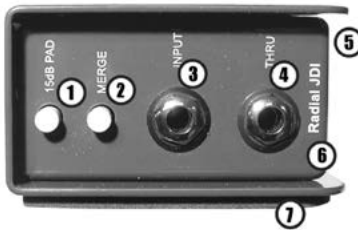

(1) **15dB PAD** switch - a -15dB pad can be introduced to reduce the input voltage and ensure a clean, distortion-free signal.

(2) **MERGE** switch - left-right mix function turns the input and thru-put connectors into a pair of left-right inputs with a mono output at the XLR.

(3) **INPUT** - 1/4" jack, 130k Ohm instrument input.

(4) **THRU** - 1/4" jack, thru-put to send instrument signal through to the instrument amplifier.

(5) **Protective bookend cover** overhangs the chassis providing protection for switches and connectors.

(6) **Welded I-beam construction** for maximum strength and durability and a baked enamel finish offer years of trouble free performance.

(7) **Full bottom no-slip pad** - reduces slipping in use and provides mechanical and electrical isolation.



(8) **Double sided PC board** - military grade circuit board features a full ground plane for maximum protection against stray magnetic fields and RF noise.

(9) **XLR** output connector - wired to the AES standard with pin-1 ground and pin-2 hot, provides a balanced 150 Ohm mic level signal.

(10) **POLARITY** switch - 180° polarity reverse toggles the XLR pin-2 and pin-3 to interface with older equipment. Also used when combining two sources such as a mic and a DI.

(11) **GROUND** switch - lifts the XLR pin-1 ground at the output to eliminate hum and noise caused by ground loops.

(12) **SPEAKER** switch - a pad circuit that allows you to tap the signal from a speaker cabinet. Features a band-pass filter to emulate a 12" driver. **Note: Only use in parallel with a speaker cabinet or load box.**

Part 3 – The JDI Quick Start

This section is for advanced users — it provides a quick set of instructions for those that are familiar with direct boxes and gets right down to action! We suggest that you read through the entire manual for a better understanding of your JDI.

Caution! *When connecting or disconnecting any audio device always ensure the power is off or all levels are set to zero. This practice will reduce the opportunity for any noise such as a capacitor discharge from being sent through the amplifier to the speakers, which could cause a big bang in your sound system or even cause a speaker to blow. This is especially true with phantom powered equipment.*

The Radial JDI is a passive direct box and as such does not require any external power such as phantom or batteries to make it work. Just plug-in and play!

To start, make sure all switches are in the outward position. Plug the instrument into the INPUT. Connect the THRU to the guitar amplifier or keyboard mixer and the XLR OUTPUT to the PA or mixing console. Set the PAD to 0dB. Slowly turn up the input level at the mixer and listen. See the Part 5 'Features and Functions' section about the MERGE function.

The JDI's Jensen audio transformer should be able to handle most instrument signal levels without distortion. At exceptionally high signal levels, the –15dB pad should be used to reduce the input level to the transformer. If you hear distortion, simply depress the –15dB pad button. If you intend to use the JDI in parallel with a speaker load, it is important that you read the details on this application in the 'Part 5 - Features and Functions' section of this manual.

Since the Radial JDI employs an audio transformer, you are actually isolating the electrical connections between the input and output. This will usually eliminate all buzz and hum caused by so called ground loops. The JDI is designed to be grounded at either the input or the output side of the transformer. If you encounter 60-cycle hum or noise, lift the ground at the XLR output. This will assume the JDI is deriving its ground at the input from the instrument or instrument amplifier.

The JDI also features a polarity reverse. This reverses pin-2 and pin-3 at the XLR. The JDI follows the "pin-2 hot" AES standard; reversing the polarity is generally not required unless the instrument is being both DI'd and mic'd. The polarity reverse switch would allow both the mic and the JDI to be set 'in phase' should these be reversed.

You are ready to go! Now... close your eyes and listen. The JDI is without a doubt, one of the most musical DI boxes ever manufactured.

Part 4 – Direct Box Basics

What is a direct box anyway?

The name 'direct box' comes from 'direct insertion box'. This is why these marvelous contraptions are also called DI's. 'Direct Insertion' means exactly that: *To insert a signal directly or take an audio signal from the source and send it **directly** to a mix point or recorder.* We take this very seriously with all our direct boxes and as such, have designed them to reproduce the most accurate 'picture' of the source no matter what the instrument.

Direct boxes perform the important function of impedance matching and signal balancing. This means that they take the high impedance output from a guitar or keyboard and 'transform' it to the low impedance signal used in a balanced sound system. Balanced signals inherently cancel noise and due to their lower impedance, can travel much further without degradation. Balanced signals are the norm in professional recording, broadcast and live sound. By properly matching the impedance you will enjoy better sound, less noise and an extended frequency response.

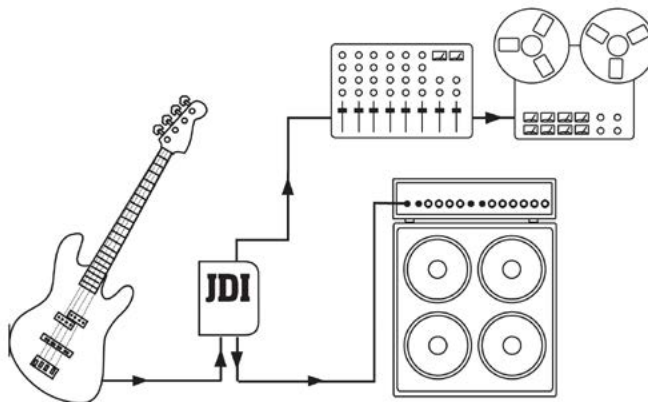

Getting to know your Radial JDI

As a rule, all direct boxes follow the same basic procedures when connecting them to a sound system. The instrument plugs into the INPUT jack, the musician's instrument amplifier connects to the THRU jack and the mixer or recorder is connected to the XLR OUTPUT. Since the XLR output connection to the mixer taps the signal **before** it goes to the musician's amplifier, this allows the mixing engineer to 'capture' the signal **before** it is modified by the musician, thus resulting in the purest source possible. *It is important to note that what may sound good on stage may not necessarily sound good in the venue.*

By sending an unaltered signal to the front of house mix position (FOH), the engineer is able to get the sound he is looking for with minimal phase and harmonic distortion. This is likely the main reason why Radial direct boxes are so popular with sound engineers — Radial DI's do not alter the sound in any way before it gets to the mixing desk.

High to low impedance conversion and balancing

The Radial JDI features a high 140k Ohm input impedance for the instrument. As the signal passes through the JDI to the XLR output, it is converted to a balanced 150 Ohm low impedance signal. This allows long cable runs without introducing noise into the audio signal path. It is important to note that the output of the Radial JDI is a mic level signal. This allows the JDI to be used along side other microphone signals without introducing cross-talk or causing transformer saturation when driving the signal through the mic bridging transformers of a splitter.

The magic of a great transformer

The Radial JDI is a passive direct box. This means that it employs a transformer to convert the impedance and balance the signal. At Radial, we believe quality should always be the most important deciding factor in any product design and the best way to make great products is to use the very best parts. Many Radial products incorporate **Jensen**® audio transformers which are expensive, but to an audiophile, these transformers are worth their weight in gold. A good transformer must be able to pass every frequency between 20Hz and 20,000Hz flawlessly. The transformer must also ensure that all of these frequencies retain their time-base relationship or 'absolute phase'. In other words, whatever you send in should come out at the same time. If the bass and mid range are not synchronized in perfect phase, it simply will not sound as good.

A transformer is a simple device. It is basically made up of three components: (1) the primary or input coil, (2) the core material and (3) the output coil. The audio signal enters the primary coil and taking full advantage of Faraday's law of electromagnetism, the coil converts the electron impulse (current) into a magnetic field. The core acts like a conduit to contain the magnetic field and drives it into the secondary coil. A magnetic field, when driven into a coil, generates current flow. Varying the number of windings on the input and the output allows us to control the input and output impedance ratio. This is where the specification '10k : 150 Ohms' comes from.

The beauty of a transformer is that there is no electrical connection between the primary and the secondary. The signal is 'transformed' from electrical energy to magnetic, then back to electrical; in effect, a 'magnetic bridge'. This provides two huge benefits: with no electrical path, ground loops are eliminated and when properly designed, a tremendous reduction in common-mode noise is possible. In the 'real world' (not the test bench) signals are never truly balanced, leaving the door open for noise to pollute the audio signal. Electronically balanced circuits (active circuits) are ill equipped to manage this common mode noise, whereas the JDI provides exceptional noise rejection at 60Hz – the crest of hum and buzz.

An audio laboratory test called 'The Green Report' (visit www.radialeng.com for details) pitted the JDI against three other direct boxes commonly used in professional audio. The tests showed that the JDI could handle more gain before distortion, was more linear throughout the audio frequency range and showed significantly less phase distortion. All boxes tested well at 1kHz, but as the frequency dropped, the 'ugly truth' started to appear. One popularly used DI was almost 20° out of phase at 20Hz while another was almost 40° out of phase! The JDI tested at less than 4° off the mark, making it the most phase accurate DI on the planet.

With its high signal level handling, dynamic response and unmatched phase accuracy, the JDI is a significantly better choice for bass, keyboard and acoustic guitars with built-in pre-amps and this can be directly attributed to the quality of the Jensen transformer we use.

The Problem:

Ground loop formed between connected equipment by the signal cable and AC power cables.

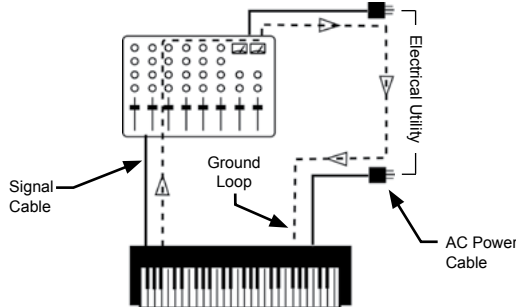

The Cure:

An audio transformer (DI box) is introduced at the signal cable eliminating the loop.

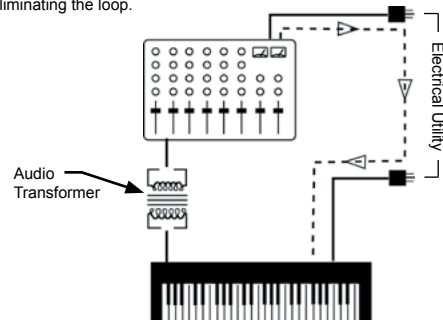

Part 5 – Features and Functions

The ¼" INPUT and THRU connectors

The JDI features two ¼" jacks on the input panel. These are designed to accept instrument inputs from basses, guitars, keyboards, drum machines, etc. The left ¼" input jack is normally connected to the source instrument. The right ¼" jack is normally used as a parallel 'thru' connector and feeds the instrument signal to the musician's on-stage amplifier.

Using the 'thru' jack with an on-stage amplifier allows both the musician and the engineer to work with the original signal direct from the instrument (*Fig. A*). This way, the musician can set up his stage sound with his own EQ while the audio engineer can process the instrument to sound good in the venue through the PA system.

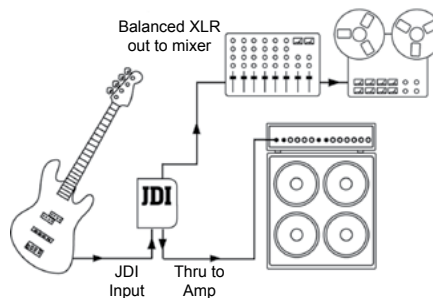

Fig. A: JDI used with on-stage instrument amplifier.

Some instruments do not use on-stage amplification. It is common for instruments such as acoustic guitar to be connected directly to the PA system through the JDI using only the balanced XLR output (*Fig. B*). This allows the signal to feed the stage snakes, monitor mixer for foldback and main PA, just like microphone signals do. In this case, the thru jack would not be used.

The MERGE switch

The JDI features an innovative 'merge' function that turns the input and the thru-put into a 'left-right to mono' mix. Depressing the merge switch introduces a resistive mixer circuit that sums the two channels at the XLR output. This function allows two sources such as a stereo keyboard or CD player to merge to 'mono', saving valuable channels on the snake and the mixer when you have more sources than available inputs.

To 'merge' simply connect two instruments with similar output levels into the IN and THRU jacks, depress the MERGE switch to the ON position and you are set to go. The internal resistive mixer is set up to do this without introducing any problems such as phase cancellation.

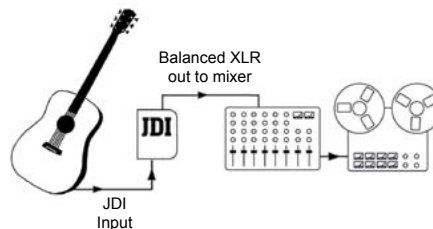

Fig. B: JDI used with acoustic instrument direct to audio system.

Input distortion and the -15dB PAD switch

Today, many acoustic guitars and basses have battery powered active pre-amplifiers that boost their pickup output signal. These high gain pre-amps often generate between 2 to 7 volts at their outputs. This high voltage can saturate the input of most direct boxes causing a harsh square wave distortion. This is most prevalent with active phantom powered direct boxes that simply do not have sufficient headroom or rail voltage to handle these transients.

The JDI is designed to handle these signal levels without fear of overloading and is one of the main advantages you will enjoy with your JDI. However, you may occasionally encounter devices with extremely high output levels such as from CD players, a mixer output or even a headphone out that can overdrive the circuit or saturate the transformer. For these rare occasions, the Radial JDI is equipped with a -15dB pad to ensure a clean and distortion-free signal is obtained.

The balanced XLR output

The JDI features a mic level, balanced output jack that uses a standard XLR male connector. This jack is wired to the AES (Audio Engineering Society) standard with pin-1 ground, pin-2 hot and pin-3 cold. Today, pretty much all equipment is manufactured using this standard. Connection is made to the mic-level input of the mixing console or to a standard mic pre-amplifier. The JDI is ideally suited for interface with concert snake systems and splitters where mic and direct box signals are directed to several destinations at the same time such as recording, monitor, broadcast and front-of-house mix positions.

The 180° POLARITY switch

A polarity reverse toggles the XLR pin-2 and pin-3 as the 'hot' or positive signal. This provides several operational benefits: interfacing with older mixing consoles that have pin-3 hot is simply a matter of depressing the polarity reverse. When combining mic and JDI signals from the same instrument, one sometimes encounters 'phase' problems. Reversing one of the signal polarities can correct phase. Onstage, the polarity reverse can sometimes reduce feedback from acoustic instruments. This same process, while recording, provides the engineer with another 'tonal palette' and experimenting with different settings can lead to some very pleasing results.

The GROUND switch

It is common practice to ground all electrical devices in a sound system. Proper grounding assures safe use and generally helps reduce system noise. As the Radial JDI is an interface, it is often placed between two grounded AC powered devices such as a keyboard and a mixer. Often these two devices will be connected to different AC outlets or may have very different ground reference potentials. When connected together, these can sometimes cause 60-cycle hum or a loud system buzz. This noise is often referred to as a ground loop.

The Radial JDI features an isolation transformer that will generally eliminate most of this type of noise. But in severe cases, lifting the ground on pin-1 at the XLR by depressing the GROUND switch can help. When lifted, it is assumed the ground will be derived by the THRU jack connection to a grounded device such as a bass amp via the audio cable shield.

Note that when you are 'going direct' by connecting a bass or acoustic guitar to the Radial JDI *without* using the thru-put, the ground switch should be set in the outward position so that the JDI is grounded at the mixing console. If you are using the thru-put to your personal amp, then your amp and the mixer will have ground paths and lifting the ground would then be considered.

Parallel speaker connection and the SPEAKER switch

IMPORTANT: THE JDI IS NOT A LOAD BOX! You must ensure that the amplifier is connected to its' speaker load first as the JDI is not designed to handle the load on its own.

There are occasions when you may wish to 'tap' the 'wet' signal off the output side of an amplifier as opposed to taking the 'dry' signal directly from the instrument. Examples would be capturing the EQ and compression settings from a bass amplifier, recording the distorted sound of a guitar amplifier, or maybe combining the sound of a mic'd amplifier with a direct feed off the speaker.

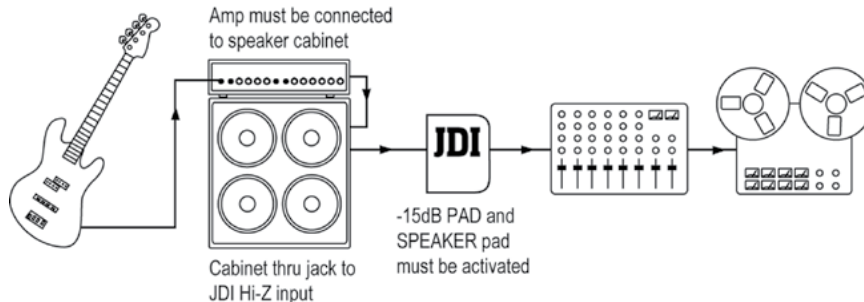

The JDI's parallel speaker connection feature lets you do this by connecting the JDI directly to the speaker cabinet. It is important to note that the JDI is NOT a load box; ***you must*** have a load such as a speaker connected to the amplifier, as ***connecting the JDI directly without a load could cause severe damage to the equipment.***

Connect your amp as usual, then connect a ¼" to ¼" speaker cable from the second (parallel) speaker cabinet jack to the JDI. Because of the high impedance and low draw from the JDI, the amp will only see the speaker cabinet, so you do not have to change the amplifier's impedance setting. Depressing BOTH the -15dB PAD switch and the SPEAKER switch inserts a special circuit that will protect the JDI from overload and allow the parallel speaker connection to be made safely. Depressing the SPEAKER switch also introduces a band-pass filter circuit that rolls off high and low frequencies to simulate the performance of a typical 12" speaker cabinet.

Mechanical attributes

All Radial products display the results of our relentless pursuit of durability. Look inside a JDI and you will note that it is literally two boxes in one. First, there is an internal heavy-duty welded 'I-beam' chassis which houses the circuit board. Second, an external shell with a 'book-end' design protects the switches and jacks from the rigors of touring. Both boxes are made from 14 gauge steel and protected by a heavy baked enamel finish that will look great even after years of service. Inside, the mil-spec PC board is two-sided which means that all components are soldered twice. Furthermore, the two piece enclosure is very rigid making it impossible to torque the PC board ensuring years of noise-free performance without solder joint failure.

The JDI is also outfitted with a full bottom no-slip pad for two important reasons: it provides plenty of 'stay-put' friction on hectic stages to keep your DI from sliding around or falling when stacked. It also works as an electrical isolator when placed on or around guitar amps – many amp heads have handles or hardware which is sometimes connected to the amp's chassis or circuit. The isolation pad helps minimize the possibility of shock hazards, especially with older amplifiers.

J-Rak and J-Clamp optional mounting kits

The J-Rak is an innovative rack shelf/chassis that lets you rack-mount up to eight Radial JDI's, J48's or the other similarly sized Radial J-Class products into a high-density 2-RU space. Each unit can be front or rear mounted allowing the system designer to have the XLR's on the front or rear of the rack, depending on the application. The J-Clamp is a mounting adapter that allows any of the Radial J-Class products to be permanently mounted in locations such as in podiums, under board room tables and inside amplifier and effect racks. Features a heavy-duty steel shell with built in mounting flange and user-writable tabs.



Part 6 – Other cool uses for your JDI

Use the Radial JDI to re-amplify your signal!

Today, a popular studio effect is to record a signal such as guitar, voice or keyboard on a track and then play the pre-recorded track back through a guitar amplifier or effect pedal. This effect is known as reamping or re-amplifying. It was started by Les Paul in the 1950's and was widely used on recordings by the Beatles in the 60's, and by Steely Dan in the 1970's.

The Radial JDI can be used 'backwards' to convert a low-impedance mic level signal back to a high-impedance guitar signal. Simply connect the output from the recorder to a mixer and the mixer's output to the JDI's XLR output using a female-to-female XLR turn-around adaptor. Keep your level down to ensure the signal will not overload the JDI's transformer. Connect the 'input' of the JDI to the input of the guitar amplifier and you are set to go!

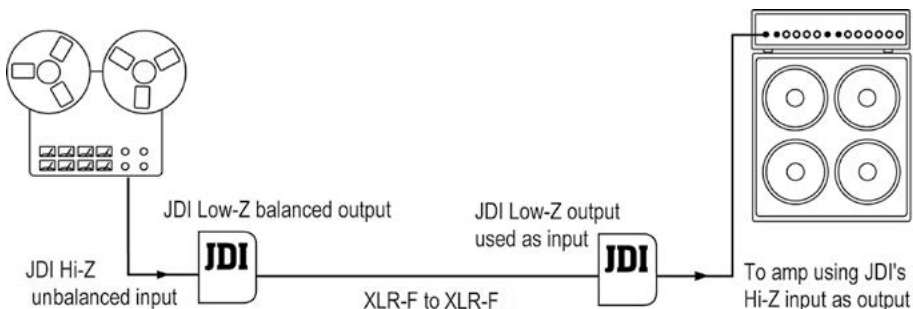

Part 7 - Frequently Asked Questions

Q: What is the difference between active & passive?

A: Active DI's have a built-in pre-amp that requires battery or 48V phantom power to run, while passive DI's use a transformer to convert the signal and do not require any power supply. Both 'transform' or convert the instrument's high-impedance output to a low impedance balanced microphone level. This allows long cable runs without adding unwanted noise. Passive boxes have the advantage of providing transformer isolation, which can reduce ground hum and noise in systems.

Q: Which is better – active or passive?

A: Both have their place just like dynamic and condenser microphones. Passive DI's are often easier to use because they do not require power while active DI's tend to have more reach. As a rule, passive direct boxes are preferred for electrically powered devices such as keyboards and electronic drums.

Q: Why do people use passive direct boxes?

Passive direct boxes are often chosen as they are 'plug & play' easy to use. When equipped with a high quality transformer, they can handle exceptionally high signal levels without harmonic distortion and a good one like the JDI will process the signal without introducing artifacts such as phase distortion. Best of all, passive DI's eliminate ground loops!

Q: Why do people use active direct boxes?

A: There are two reasons that active DI boxes like the Radial J48 have become popular. To get good sound with a passive direct box, you need to use a high quality transformer like a Jensen, which can be quite expensive. This cost dissuades many manufacturers from building passive DI's, while an active direct box can be made much more inexpensively. The other reason is that back in the 1970's and 1980's when DI's first showed up, most instruments used passive pickups and these generally had very low output levels. Passive DI's with inefficient transformers would 'load' down the pickup and cause the sound to change. Active (buffered or amplified) direct boxes could be made with a high input impedance that would not load down the pickups, which solved the loading issue.

Q: Can you explain impedance loading?

A: Years ago, most instruments used passive, low output pickups. Passive pickups "see" the device it is connected to, such as an amplifier input, as a load it must drive with it's output signal. Musicians found that connecting their passive instruments to both a direct box and an amplifier caused the sound to change. This happens because the signal is split between two impedance loads. The instrument amplifier presents one load on the pickups and the DI's transformer adds a second load. Each device draws on the passive signal and this reduces the level going to the instrument amplifier causing it to sound different when compared to a straight instrument-to-amp connection.

Q: Why is loading less of a concern?

A: Back in the 1970's, acoustic guitars did not have the sophisticated pickups and built-in pre-amps that are standard now. Today, most electric basses incorporate high-output pickups or have active electronics built in. Acoustic guitar pre-amps and keyboards can have equally high output levels. These high output levels are so powerful that loading is no longer the concern. The 'fix' has in fact caused a new problem – input distortion or saturation.

Q: But I have heard that active DI's are better?

A: Active DI's can be good but they can have several disadvantages. Active direct boxes require power. As such, they must either run off batteries or 48V phantom power from the console. When power is low, they distort more easily. This means that for the direct box to work well, you must have fresh batteries. Furthermore, today's high output active instruments often overload the direct box input because it is unable to handle the increased dynamic range of active pickups. This causes harsh square wave distortion known as clipping that makes acoustic guitars sound "edgy" and bass and keys sound "thin". Finally, most active direct boxes do not provide isolation from ground loops. Transformers do this naturally and in doing so, eliminate hum and buzz caused by ground loops.

Q: What is phantom power and will it harm my JDI?

A: Phantom power is a DC supply that comes from the mixing console that was originally designed to provide power to condenser microphones. It is typically 48 volts and about 5mA. When phantom is on, it will not harm the JDI.

Q: What is phase distortion?

A: Keeping your signal in phase is akin to making sure that when you play guitar, the sound coming from the low E-string plays at the same time as the G-string as they come out of your amp. You may take this for granted but the fact is, phase distortion can cause an instrument to get lost in the mix and make a bass sound muddy. Phase distortion can occur at all frequencies but is most noticeable in the bass or low frequencies. Try facing your stereo speakers close together and then reverse the speaker wires on one cabinet so that it is wired out-of-phase. You will immediately become an 'in-phase disciple'. When we tested several popular direct boxes for phase deviation, we found that most were fine at 1000Hz. What surprised us is how poorly the other DI's performed at 20Hz. One popular direct box was 40° out of phase, while another was 20° out! The Radial JDI tested at less than 4°. We spend thousands of dollars on PA systems to ensure they are time aligned (in phase) since a bad direct box can ruin the sound before it gets to the mix position!

Q: What is the difference between phase and polarity?

A: This is often confused. Reversing the polarity means switching the (+) wire with the (-) wire in an electrical connection. Reversing the **phase** has to do with the time domain. When a frequency is delayed by 180° and played with the original, the out of phase signals cancel each other out. Reversing the polarity of one of two speakers has the same audible effect.

Q: Is a flat frequency response better than a colored response?

A: This is a good question. When buying a large condenser microphone, you are most often not getting a flat response mic, but a mic colored or flavored to add to your sound palette. Most studios boast a selection of mics and the sign of a good engineer is one that knows 'which mic to use on what' in order to get a particular tone. With direct boxes, this is usually not the case. If the sound of the guitar is not right, one will usually change the guitar, not the direct box, therefore we believe the role of the direct box is to transport the original signal as faithfully as possible from the instrument to the destination and allow the engineer and producer to make the artistic choices. Here's more food for thought... should the direct box change the tone of the instrument? If it makes your Strat sound fat, will it make your Les Paul muddy? We think a properly designed DI should be faithful to the source. The Radial JDI direct box gives the engineer and producer a natural and uncolored sound to work with.

Q: What about tube direct boxes?

A: Tube direct boxes are cool and there is a definite place for them in the recording world. Tube DI's introduce personality to the sound and should be viewed in the same way as one views a tube microphone.

Q: If my JDI ever fails, what do I do?

A: In the past 10 years the JDI has been so reliable that it is a rare occurrence when we need to repair one. If however something goes bad, a switch for example, simply call Radial and we will issue a return authorization number for you to send it back to us for repair. We do suggest that before you do so, visit the dealer where you bought it and have them check it out before sending it away. Often times, it turns out that bad cables are the actual problem.

Q: What is the warranty on the JDI?

A: The Radial JDI carries a 3-year warranty while the Jensen® transformer inside carries a 20-year warranty. Repairing the transformer can be done either through Radial or directly with Jensen Transformers.

Q: Can I rack-mount the Radial JDI?

A: Yes. This is easily done with the Radial J-Rak. The J-Rak is a 2RU shelf that holds as many as 8 Radial small format direct boxes, like the JDI or J48 which can be front or rear-mounted depending on your intended application.

Q: Can I rack-mount the Duplex?

A: No. The Radial JDI Duplex is designed as a stand-alone device. If you are looking for a rackmount solution that takes up even less space than the J-Rak, the 1-RU Radial JD6 may be your solution with 6 JDI channels in 1 RU space.

Part 8 – Block diagram and specifications

JDI Block Diagram

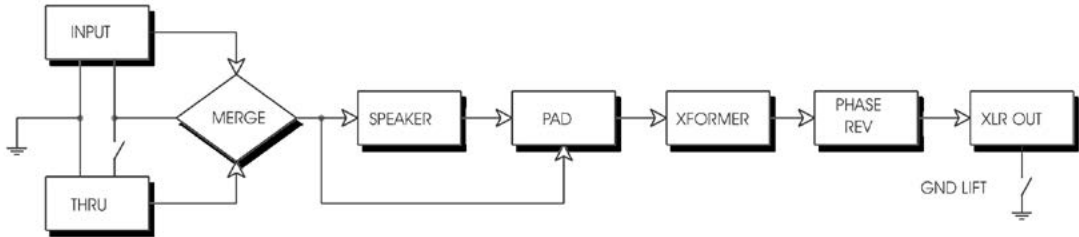

JDI Specifications	
Type:	Passive Jensen Transformer equipped
Input impedance:	Unbalanced 140k Ohms typical
Output impedance:	Balanced 150 Ohms typical
Frequency response:	20Hz to 20kHz (+/- 0.2dB)
Linear performance:	< -0.22 dBr deviation @20kHz
Total harmonic distortion:	0.05% @ 20Hz, 0.006% @ 1kHz
Phase distortion:	3° at 20Hz, 0.3° at 100Hz
Maximum input level:	+21dBu @ 20Hz (1% THD)
Size:	3.5" wide, 2" high, 5.5" deep
Weight:	1kg / 2.2lbs
Construction:	Welded 14-gauge steel
Finish:	Baked enamel finish

RADIAL ENGINEERING 3 YEAR TRANSFERABLE WARRANTY

RADIAL ENGINEERING LTD. ("Radial") warrants this product to be free from defects in material and workmanship and will remedy any such defects free of charge according to the terms of this warranty. Radial will repair or replace (at its option) any defective component(s) of this product (excluding finish and wear and tear on components under normal use) for a period of three (3) years from the original date of purchase. In the event that a particular product is no longer available, Radial reserves the right to replace the product with a similar product of equal or greater value. To make a request or claim under this limited warranty, the product must be returned prepaid in the original shipping container (or equivalent) to Radial or to an authorized Radial repair center and you must assume the risk of loss or damage. A copy of the original invoice showing date of purchase and the dealer name must accompany any request for work to be performed under this transferable warranty. This limited warranty shall not apply if the product has been damaged due to abuse, misuse, misapplication, accident or as a result of service or modification by any other than an authorized Radial repair center.

THERE ARE NO EXPRESSED WARRANTIES OTHER THAN THOSE ON THE FACE HEREOF AND DESCRIBED ABOVE. NO WARRANTIES WHETHER EXPRESSED OR IMPLIED, INCLUDING BUT NOT LIMITED TO, ANY IMPLIED WARRANTIES OF MERCHANTABILITY OR FITNESS FOR A PARTICULAR PURPOSE SHALL EXTEND BEYOND THE RESPECTIVE WARRANTY PERIOD DESCRIBED ABOVE OF THREE YEARS. RADIAL SHALL NOT BE RESPONSIBLE OR LIABLE FOR ANY SPECIAL, INCIDENTAL OR CONSEQUENTIAL DAMAGES OR LOSS ARISING FROM THE USE OF THIS PRODUCT. THIS WARRANTY GIVES YOU SPECIFIC LEGAL RIGHTS, AND YOU MAY ALSO HAVE OTHER RIGHTS, WHICH MAY VARY DEPENDING ON WHERE YOU LIVE AND WHERE THE PRODUCT WAS PURCHASED.



Radial Engineering Ltd.
1845 Kingsway Ave., Port Coquitlam, BC V3C 1S9, Canada
Tel: 604-942-1001 • Fax: 604-942-1010
Email: info@radialeng.com

JD1 User Guide v2.4 / 10-2021 Part #: R870 1000 00 Copyright © 2009 - all rights reserved.
Features, appearance and specifications subject to change without notice.

www.radialeng.com