

IMPORTANT SAFETY INSTRUCTIONS









1. READ these instructions.
2. KEEP these instructions.
3. HEED all warnings.
4. FOLLOW all instructions.
5. DO NOT use this apparatus near water.
6. CLEAN ONLY with dry cloth.
7. DO NOT block any ventilation openings. Allow sufficient distances for adequate ventilation and install in accordance with the manufacturer's instructions.
8. DO NOT install near any heat sources such as open flames, radiators, heat registers, stoves, or other apparatus (including amplifiers) that produce heat. Do not place any open flame sources on the product.
9. DO NOT defeat the safety purpose of the polarized or grounding type plug. A polarized plug has two blades with one wider than the other. A grounding type plug has two blades and a third grounding prong. The wider blade or the third prong are provided for your safety. If the provided plug does not fit into your outlet, consult an electrician for replacement of the obsolete outlet.
10. PROTECT the power cord from being walked on or pinched, particularly at plugs, convenience receptacles, and the point where they exit from the apparatus.
11. ONLY USE attachments/accessories specified by the manufacturer.
12. USE only with a cart, stand, tripod, bracket, or table specified by the manufacturer, or sold with the apparatus. When a cart is used, use caution when moving the cart/apparatus combination to avoid injury from tip-over.



13. UNPLUG this apparatus during lightning storms or when unused for long periods of time.
14. REFER all servicing to qualified service personnel. Servicing is required when the apparatus has been damaged in any way, such as power supply cord or plug is damaged, liquid has been spilled or objects have fallen into the apparatus, the apparatus has been exposed to rain or moisture, does not operate normally, or has been dropped.

15. DO NOT expose the apparatus to dripping and splashing. DO NOT put objects filled with liquids, such as vases, on the apparatus.
16. The MAINS plug or an appliance coupler shall remain readily operable.
17. The airborne noise of the Apparatus does not exceed 70dB (A).
18. Apparatus with CLASS I construction shall be connected to a MAINS socket outlet with a protective earthing connection.
19. To reduce the risk of fire or electric shock, do not expose this apparatus to rain or moisture.
20. Do not attempt to modify this product. Doing so could result in personal injury and/or product failure.
21. Operate this product within its specified operating temperature range.

Explanation of Symbols

-  Caution: risk of electric shock
-  Caution: risk of danger (See note.)
-  Direct current
-  Alternating current
-  On (Supply)
-  Equipment protected throughout by DOUBLE INSULATION or REINFORCED INSULATION
-  Stand-by
-  Equipment should not be disposed of in the normal waste stream

WARNING: Voltages in this equipment are hazardous to life. No user-serviceable parts inside. Refer all servicing to qualified service personnel. The safety certifications do not apply when the operating voltage is changed from the factory setting.

Important Product Information

LICENSING INFORMATION

Licensing: A ministerial license to operate this equipment may be required in certain areas. Consult your national authority for possible requirements. Changes or modifications not expressly approved by Shure Incorporated could void your authority to operate the equipment. Licensing of Shure wireless microphone equipment is the user's responsibility, and licensability depends on the user's classification and application, and on the selected frequency. Shure strongly urges the user to contact the appropriate telecommunications authority concerning proper licensing, and before choosing and ordering frequencies.

Information to the user

This equipment has been tested and found to comply with the limits for a Class B digital device, pursuant to Part 15 of the FCC Rules. These limits

are designed to provide reasonable protection against harmful interference in a residential installation. This equipment generates uses and can radiate radio frequency energy and, if not installed and used in accordance with the instructions, may cause harmful interference to radio communications. However, there is no guarantee that interference will not occur in a particular installation. If this equipment does cause harmful interference to radio or television reception, which can be determined by turning the equipment off and on, the user is encouraged to try to correct the interference by one or more of the following measures:

- Reorient or relocate the receiving antenna.
- Increase the separation between the equipment and the receiver.
- Connect the equipment to an outlet on a circuit different from that to which the receiver is connected.
- Consult the dealer or an experienced radio/TV technician for help.

Note: EMC conformance testing is based on the use of supplied and recommended cable types. The use of other cable types may degrade EMC performance.

Please follow your regional recycling scheme for batteries, packaging, and electronic waste.

WARNING: This product contains a chemical known to the State of California to cause cancer and birth defects or other reproductive harm.

This device complies with Industry Canada licence-exempt RSS standard(s). Operation of this device is subject to the following two conditions: (1) this device may not cause interference, and (2) this device must accept any interference, including interference that may cause undesired operation of the device.

Le présent appareil est conforme aux CNR d'Industrie Canada applicables aux appareils radio exempts de licence. L'exploitation est autorisée aux deux conditions suivantes : (1) l'appareil ne doit pas produire de brouillage, et (2) l'utilisateur de l'appareil doit accepter tout brouillage radioélectrique subi, même si le brouillage est susceptible d'en compromettre le fonctionnement.

WARNING: Danger of explosion if incorrect battery replaced. Operate only with AA batteries.

Note: Use only with the included power supply or a Shure-approved equivalent.

WARNING

- Battery packs may explode or release toxic materials. Risk of fire or burns. Do not open, crush, modify, disassemble, heat above 140°F (60°C), or incinerate.
- Follow instructions from manufacturer
- Only use Shure charger to recharge Shure rechargeable batteries
- **WARNING:** Danger of explosion if battery incorrectly replaced. Replace only with same or equivalent type.
- Never put batteries in mouth. If swallowed, contact your physician or local poison control center
- Do not short circuit; may cause burns or catch fire
- Do not charge or use battery packs other than Shure rechargeable batteries
- Dispose of battery packs properly. Check with local vendor for proper disposal of used battery packs.
- Batteries (battery pack or batteries installed) shall not be exposed to excessive heat such as sunshine, fire or the like

Australia Warning for Wireless

This device operates under an ACMA class licence and must comply with all the conditions of that licence including operating frequencies. Before 31 December 2014, this device will comply if it is operated in the 520-820 MHz frequency band. **WARNING:** After 31 December 2014, in order to comply, this device must not be operated in the 694-820 MHz band.

Quickstart Instructions

General Description

Shure ULX-D™ Digital Wireless offers uncompromising 24-bit audio quality and RF performance, with intelligent, encryption-enabled hardware, flexible receiver options, and advanced rechargeability options for professional sound reinforcement.

A breakthrough in wireless audio quality, Shure digital processing enables ULX-D to deliver the purest reproduction of source material ever available in a wireless system, with a wide selection of trusted Shure microphones to choose from. Extended 20 Hz – 20 kHz frequency range and flat response captures every detail with clarity, presence, and incredibly accurate low end and transient response. With greater than 120 dB, ULX-D delivers wide dynamic range for excellent signal-to-noise performance. Optimized for any input source, ULX-D eliminates the need for transmitter gain adjustments.

ULX-D sets a new and unprecedented standard for spectral efficiency and signal stability. The intermodulation performance of ULX-D is an incredible advancement in wireless performance, enabling a dramatic increase in the number of simultaneous active transmitters on one TV channel. Rock-solid RF signal with zero audio artifacts extends over the entire range. For applications where secure wireless transmission is required, ULX-D offers Advanced Encryption Standard (AES) 256-bit encrypted signal for unbreakable privacy.

For scalability and modular flexibility, ULX-D receivers come in single, dual, and even quad channel versions. The dual and quad channel receivers offer conveniences such as RF cascade, internal power supply, bodypack frequency diversity, audio output channel summing, and Dante™ digital networking for multi-channel audio over Ethernet. All receivers offer High-Density mode for applications where high channel counts are needed, greatly increasing the amount of simultaneous channels possible over one frequency band.

Advanced Lithium-ion rechargeability provides extended transmitter battery life over alkaline batteries, battery life metering in hours and minutes accurate to within 15 minutes, and detailed tracking of battery health status.

Generations ahead of any other available system in its class, ULX-D brings a new level of performance to professional sound reinforcement.

Features

Uncompromising Professional Digital Wireless

- 24-bit/48 KHz digital audio that exceeds all other systems in accurate reproduction of the source material
- 20 Hz – 20 KHz frequency range with flat response
- Greater than 120 dB dynamic range for excellent signal-to-noise performance
- Advanced Encryption Standard (AES-256) for any application where secure transmission is needed:
 - AES algorithm used in Shure ULX-D™ Wireless has been validated (validation no: 2552) by the National Institute of Standards and Technology (NIST) as conforming to the Advanced Encryption Standard (AES) Algorithm, as specified in Federal Information Processing Standard (FIPS) Publication 197, Advanced Encryption Standard
 - Enabled via front panel menu and IR sync
 - Added benefit of eliminating stray RF interference by allowing only encrypted signal through to the receiver
- Built-in limiter circuitry prevents digital audio clipping from excessive signal levels.
- 60 dB of adjustable system gain easily accessible from the receiver front panel
- No transmitter gain adjustments needed - optimized for any input source
- Wide selection of trusted Shure Microphones

Extremely Efficient and Reliable RF Performance

- Up to 64 MHz overall tuning range (region dependent)
- Minimized intermodulation distortion results in significantly more channels on air, setting the bar for wireless performance in crowded RF environments
 - 17 active transmitters in one 6 MHz TV channel
 - 22 active transmitters in one 8 MHz TV channel
 - High Density mode enables up to 47 active transmitters in one 6 MHz TV channel (63 in one 8 MHz TV channel), with no audio quality degradation
 - Over 60 compatible channels on one frequency band
- Rock-solid signal stability with no audio artifacts extends over the entire 100 meter line-of-sight range using standard supplied dipole antennas
- Selectable 1, 10, and 20 mW transmitter RF output power (region dependent)
- Optimized scanning automatically finds, prioritizes, and selects the cleanest frequencies available

Rugged, Intelligent Hardware

- Optimized scanning automatically finds and deploys the cleanest frequencies available
- Proprietary Shure Gain Ranging optimizes system dynamic range for any input source, eliminating the need for transmitter gain adjustments
- Up to 60 dB of adjustable system gain is easily accessible from the receiver front panel
- Networkable receiver simplifies setup across multiple channels
- Compatible with external controllers such as AMX and Creston. Cross-subnet control enabled for management between multiple facilities or venues.
- Rugged metal housing on both transmitters and receiver
- Interference detection and alerts provide instant confirmation when interference is present
- Upgraded LCD screens with adjustable contrast and brightness on both transmitters and receivers

Advanced Rechargeability - SB900 Shure Rechargeable Battery

- Lithium-Ion chemistry and intelligent Shure battery circuitry results in rechargeable batteries with no memory effect. The battery can be recharged at any time; a complete discharge is never necessary
- Adapted from industry-leading Axient® rechargeable technology
- Lithium-Ion chemistry and intelligent Shure battery circuitry results in rechargeable batteries with zero memory effect and precision metering
- Provides ULX-D™ transmitters with greater than 11 hours of continuous use
- Transmitters and receivers display remaining battery life in hours and minutes accurate to within 15 minutes
- The SBC200 Dual Docking Charger recharges batteries while in transmitters or out
- The SBC800 Eight-Bay Charger brings up to eight SB900 batteries to full charge within three hours and 50% charge in one hour, with charge status LEDs for each battery
- AA alkaline backwards compatibility
- Both chargers fit in a standard-size rack drawer for easy transport and storage

Hardware Interface

Receiver

Front Panel

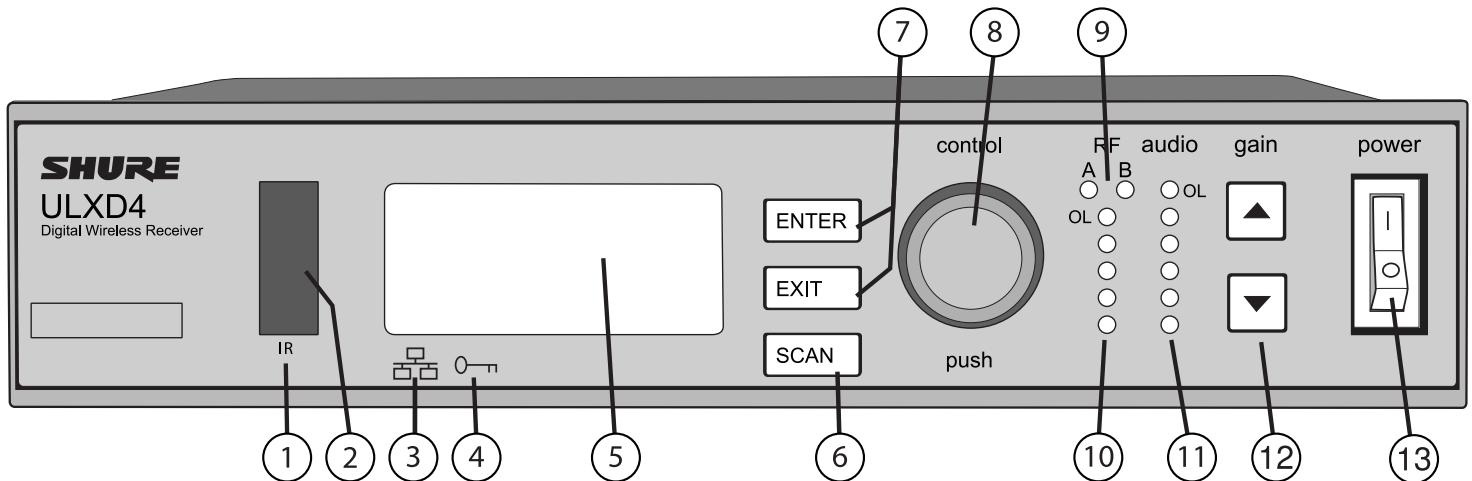

① Sync Button

Press the sync button while the receiver and transmitter IR windows are aligned to transfer settings from the receiver to the transmitter

② Infrared (IR) Sync Window

Sends IR signal to the transmitter for sync

③ Network Icon

Illuminates when the receiver is connected with other Shure devices on the network. IP Address must be valid to enable networked control

④ Encryption Icon

Illuminates when AES-256 encryption is activated: Utilities>Encryption

⑤ LCD Panel

Displays settings and parameters

⑥ Scan Button

Press to find the best channel or group

⑦ Menu Navigation Buttons

Use to select and navigate through parameter menus

⑧ Control Wheel

Push to select menu items for editing, turn to edit a parameter value

⑨ RF Diversity LEDs

Indicate antenna status:

- Blue = normal RF signal between the receiver and transmitter
- Red = interference detected
- Off = No RF connection between the receiver and transmitter

Note: the receiver will not output audio unless one blue LED is illuminated

⑩ RF Signal Strength LEDs

Indicate the RF signal strength from the transmitter:

- Amber = Normal (-90 to -70 dBm)
- Red = Overload (greater than -25 dBm)

⑪ Audio LEDs

Indicate average and peak audio levels:

LED	Audio Signal Level	Description
Red (6)	-0.1 dBFS	Overload/ limiter
Yellow (5)	-6 dBFS	Normal peaks
Yellow (4)	-12 dBFS	
Green (3)	-20 dBFS	Signal Present
Green (2)	-30 dBFS	
Green (1)	-40 dBFS	

12 Gain Buttons

Adjust channel gain

13 Power Switch

Powers the unit on or off

Back Panel

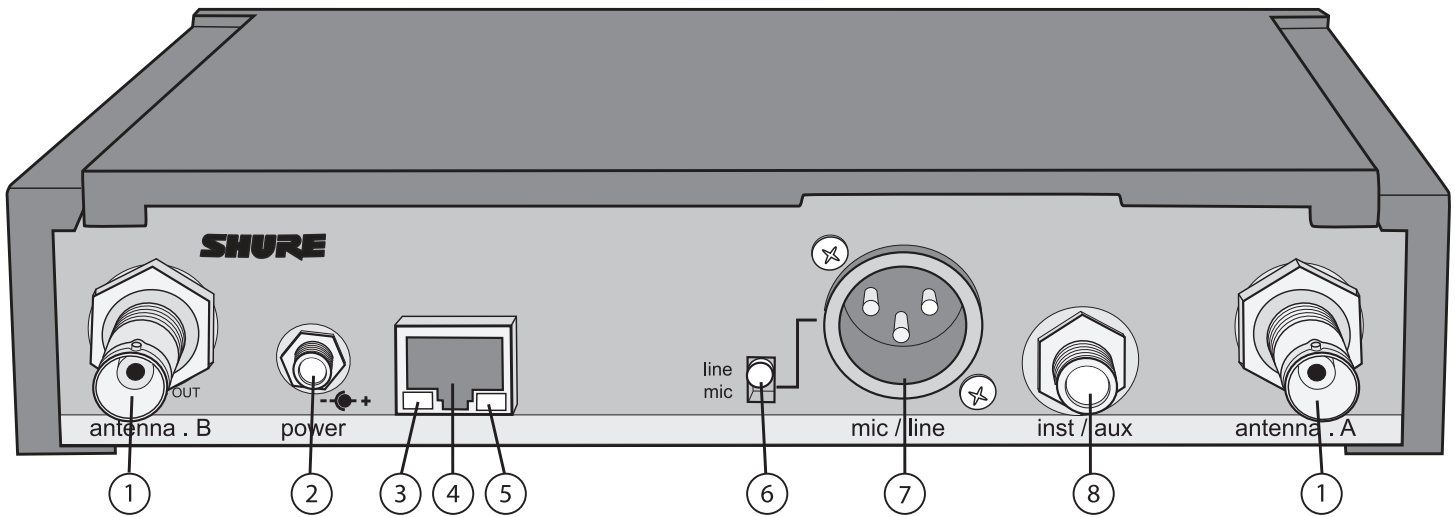

1 RF Antenna Diversity Input Jack (2)

For antenna A and antenna B.

2 Power Supply Jack

Connect the supplied 15 V DC external power supply

3 Network Speed LED (Amber)

- Off = 10 Mbps
- On = 100 Mbps

4 Ethernet Port

Connect to an Ethernet network to enable remote control and monitoring

Note: Use shielded Cat5e or better Ethernet cables for VHF (V50 and V51) to ensure reliable network performance.

5 Network Status LED (Green)

- Off = no network link
- On = network link active
- Flashing = network link active, flash rate corresponds to traffic volume

6 Mic/Line Switch

Applies a 30 dB pad in mic position (XLR output only)

7 Balanced XLR Audio Output

Connect to a mic or line level input

8 Balanced 1/4" (6.35 mm) TRS Audio Output

Connect to a mic or line level input

Transmitters

① Power LED

- Green = unit is powered on
- Red = low battery or battery error (see Troubleshooting)
- Amber = power switch is disabled

② On/Off Switch

Powers the unit on or off.

③ SMA Connector

Connection point for RF antenna.

④ LCD Display:

View menu screens and settings. Press any control button to activate the backlight.

⑤ Infrared (IR) Port

Align with the receiver IR port during an IR Sync for automated transmitter programming.

⑥ Menu Navigation Buttons

Use to navigate through parameter menus and change values.

exit	Acts as a 'back' button to return to previous menus or parameters without confirming a value change
enter	Enters menu screens and confirms parameter changes
▼▲	Use to scroll through menu screens and to change parameter values

⑦ Battery Compartment

Requires Shure SB900A rechargeable battery or 2 AA batteries.

⑧ AA Battery Adapter

- Handheld: rotate and store in the battery compartment to use a Shure SB900A battery
- Bodypack: remove to accommodate a Shure SB900A battery

⑨ Bodypack Antenna

For RF signal transmission.

⑩ Integrated Antenna

For RF signal transmission.

⑪ Microphone Cartridge

See Optional Accessories for a list of compatible cartridges.

⑫ TA4M / LEMO Input Jack

Connects to a microphone or instrument cable.

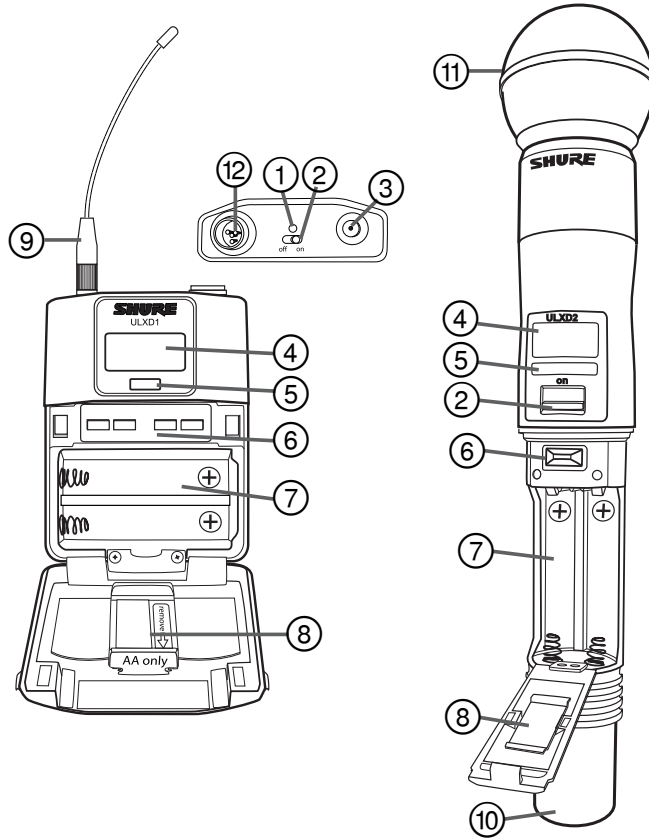

Boundary and Gooseneck Base Transmitters

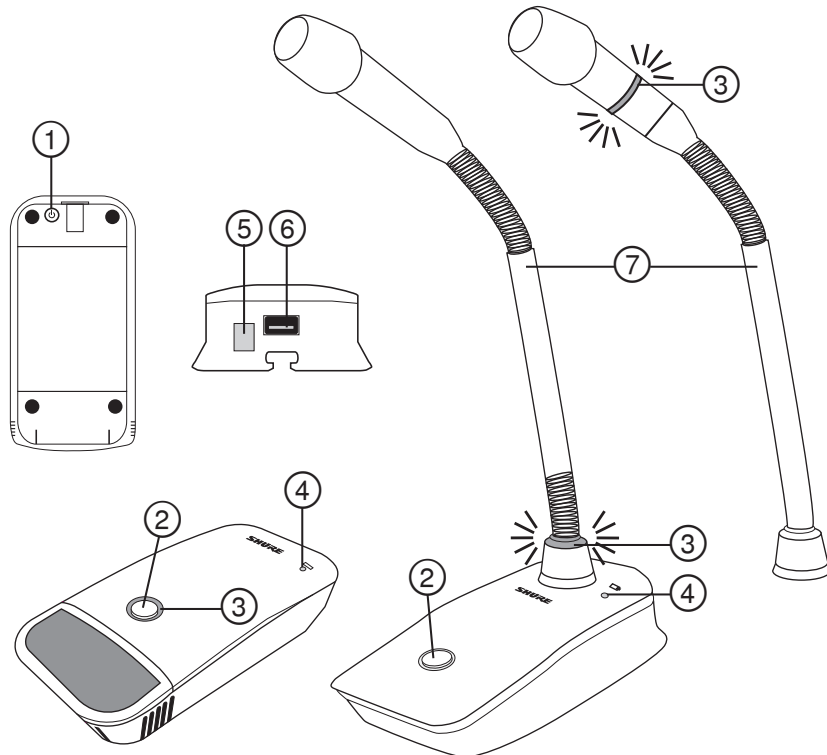

① Power Button

Press to power on; press and hold to power off.

② Mute/Active Button

Four settings are available for the mute/active button:

- Toggle: Press to switch between active and mute states
- Push-to-Mute: Hold button to mute microphone
- Push-to-Talk: Hold button to activate microphone
- Disabled: Button functionality off

③ Mute LED

Indicates whether microphone is active or muted. The following settings are available:

Active	Muted
Green*	Red*
Red	Off
Red	Flashing red

*MX400R series gooseneck microphones (red LED) do not offer this setting.

④ Low-Battery LED

- Off = More than 30 minutes of battery life remain
- On (red) = Less than 30 minutes of battery life remain
- On (green) = Microphone docked on charging station
- On (amber) = Battery is missing or is not inserted correctly

⑤ Infrared (IR) Port

Align with receiver IR port to send settings to transmitter.

⑥ Charge Connector

Connects to networked chargers and USB power supply.

⑦ Gooseneck Microphone

ULXD8 base fits 5", 10", and 15" Microflex series microphones, available in single or dualflex and with bi-color or red-only LEDs.

Advanced Transmitter Features

RF MUTE

Use this to turn on a transmitter without interfering with the RF spectrum.

Press and hold the exit button during power-on until RF MUTED is displayed. To un-mute, restart the transmitter.



Transmitter Input Clip

The following warning displays on the receiver LCD panel when the transmitter input is clipped:



To correct, set MIC.OFFSET to 0 dB and if necessary, attenuate the signal source.

If the source cannot be attenuated while using a bodypack transmitter, select INPUT PAD from the main menu to attenuate the input signal by 12 dB.

MIC.OFFSET

MIC.OFFSET compensates for signal level differences between transmitters that share the same receiver channel.

Set the offset gain on a low signal level transmitter to match a louder transmitter: UTILITY>MIC.OFFSET

Note: For normal gain adjustments, use the receiver gain buttons.

Transmitter Audio Mute Mode

Mute Mode reconfigures the transmitter power switch to act a mute switch for the audio. Using the switch, the audio can be easily turned on or muted by presenters, sports referees, or anyone who periodically needs to speak. When the audio is muted, the transmitter RF signal remains on and ready at all times.

Note: Mute Mode can be selected as an IR PRESET option.

To set a transmitter to Mute Mode:

1. From the transmitter menu: UTILITY>MUTE MODE
2. Use the arrows to select ON or OFF.
3. Press enter to save.

Tip: The transmitter LED turns red when audio is muted and turns green when audio is enabled. The display of the transmitter will show AUDIO MUTED and the receiver display will show Tx Muted.

Note: Mute Mode must be set to OFF in order to use the power switch to turn off the transmitter.

Menu Screens

Receiver Channel

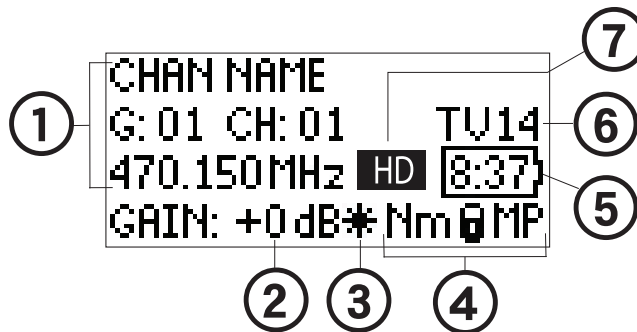

① Receiver Information

Use DEVICE UTILITIES>HOME INFO to change the home screen display.

② Gain Setting

-18 to +42 dB, or Mute.

③ Mic. Offset Indicator

Indicates offset gain is added to the transmitter.

④ Transmitter Settings

The following information cycles when a transmitter is tuned to the receiver's frequency:

- Transmitter Type
- Input Pad (Bodypack only)
- RF Power Level
- Transmitter Lock Status
- Transmitter Mute Status

⑤ Battery Runtime Indicator

Shure SB900 battery: runtime is displayed in minutes remaining.

AA batteries: runtime is displayed with a 5-bar indicator.

⑥ TV Channel

Displays the TV channel that contains the tuned frequency.

⑦ High Density Mode Icon

Displayed when High Density mode is enabled.

Transmitter Status

The following text or icons report transmitter status to the receiver screen:

Display Icon	Transmitter Status
	Bodypack input is attenuated 12 dB
	Offset gain is added to the transmitter
Lo	1 mW RF power level
Nm	10 mW RF power level
Hi	20 mW RF power level
M	Menu is locked
P	Power is locked
TxMuted	Displayed when the transmitter audio is set to off using the MUTE MODE feature
-No Tx-	No RF connection between a receiver and transmitter or transmitter OFF

Transmitter

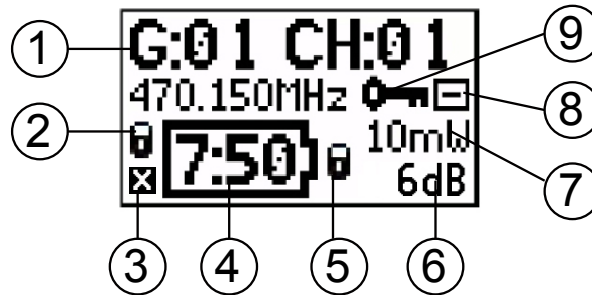

① Transmitter Information

Scroll ▲▼ at the home screen to change the display

② Power Lock Indicator

Indicates power switch is disabled

③ Transmitter Audio Muted Indicator

Displayed when the transmitter audio is set to off using the MUTE MODE feature.

④ Battery Runtime Indicator

- Shure SB900 battery: runtime is displayed in hours:minutes remaining
- AA Batteries: runtime is displayed with a 5-bar indicator

⑤ Menu Lock Indicator

Indicates menu navigation buttons are disabled

⑥ Mic. Offset

Displays microphone offset gain value

⑦ RF Power

Displays RF power setting

⑧ Bodypack Input Pad

The input signal is attenuated 12 dB

⑨ Encryption Icon

Indicates encryption is enabled on the receiver and has been transferred to the transmitter from a sync

Adjusting Receiver Display Brightness and Contrast

Adjust BRIGHTNESS and CONTRAST settings to improve visibility in challenging lighting environments.

1. From the receiver menu: DEVICE UTILITIES>DISPLAY
2. Press the control wheel to select CONTRAST or BRIGHTNESS.
3. Turn the control to adjust the selected parameter.
4. Press ENTER to save changes.

Home Screen Display Options

Receiver

The HOME INFO menu provides options to change the information shown on the receiver home screen:

DEVICE UTILITIES>HOME INFO

Use the control wheel to select one of the following screen displays.

Transmitter

Home Screen: Press the ▲▼ arrows at the home menu to display one of the following screens:

Editing Receiver Channel Name

To edit a receiver channel name, choose EDIT NAME from the menu.

- Turn the control wheel to edit a highlighted character
- Press the control wheel to advance to the next character
- Press ENTER to save changes

Note: The channel name is transferred to a transmitter during a sync.

Setting Regional TV Format

To ensure accurate display of TV channel information, set the TV FORMAT to match the TV channel bandwidth in the region where the receiver is operating. TV bandwidth varies globally, so check local regulations to determine the regional TV bandwidth.

The following TV FORMAT options are available:

- 6 MHz
- 7 MHz
- 8 MHz
- 6 MHz JAPAN
- NO TV (use to turn off TV channel display or in regions where TV channels are not applicable)

To set the TV FORMAT:

1. Menu: DEVICE UTILITIES>ADVANCED RF>TV FORMAT
2. Use the control wheel to select a TV FORMAT option.
3. Press ENTER to save.

Locking Controls and Settings

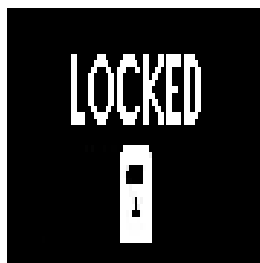

Use the LOCK feature to prevent accidental or unauthorized changes to the hardware. Attempting to access a locked feature will display the following message:

Receiver

Menu path: UTILITIES>LOCK

MENU: All menu paths are inaccessible. To unlock, press the EXIT button, turn the control wheel to select UNLOCKED and press ENTER to save.

GAIN: Gain adjustment is locked

POWER: Power switch is disabled

SCN/SYC: Cannot perform a Scan and Sync

Transmitter

Menu path: UTILITY>LOCK

MENU: All menu paths are inaccessible. To unlock, press the ENTER button four (4) times to pass through the following screens: UTILITY>LOCK>MENU UNLOCK

POWER: Power switch is disabled

Quick-Lock Option: To turn on the transmitter with its power and menu navigation buttons locked, press and hold the ▲ button during power-on until the locked message is displayed.

To unlock, turn the power switch to the off position, then press and hold the ▲ button while turning the power switch to the on position.

Batteries

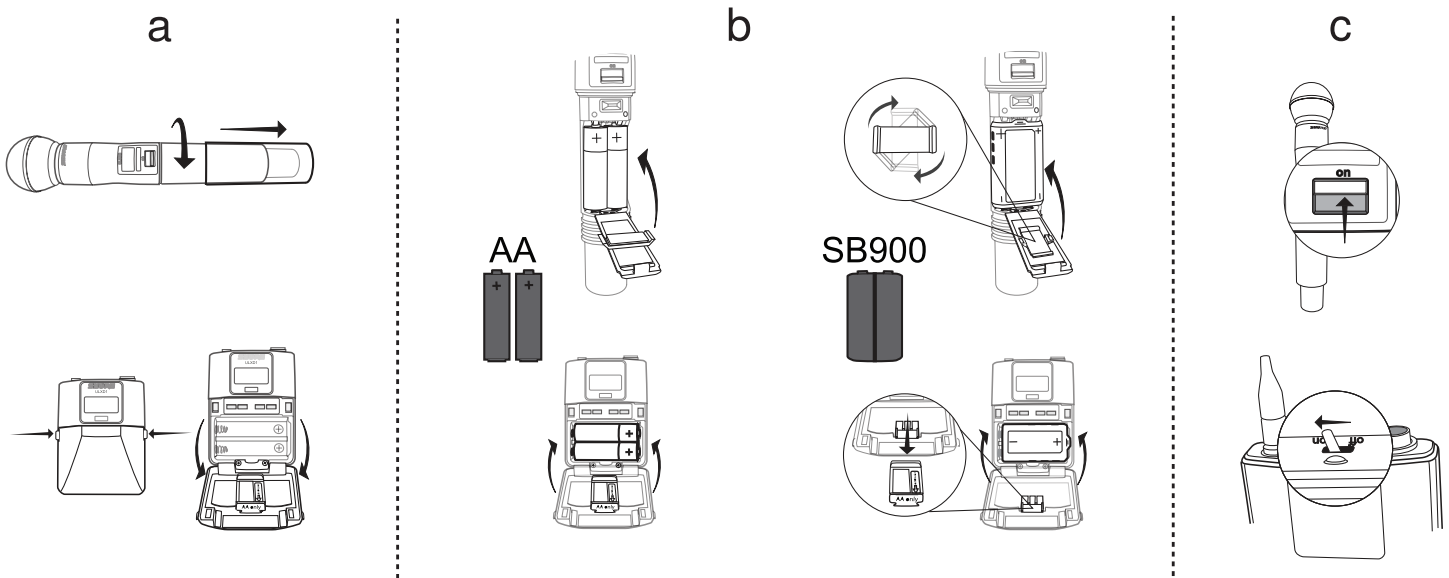

The transmitter runs on two AA batteries or the Shure SB900 rechargeable battery. Use the included AA battery adapter when using batteries other than the Shure SB900.

Bodypack: Remove the adapter when using the Shure SB900

Handheld: Rotate and store the adapter in battery door when using Shure SB900

Battery Runtime Charts

A 5-segment icon on the receiver and transmitter menu screens indicates battery charge.

For accurate battery runtime monitoring, set the transmitter to the appropriate battery type: UTILITY>BATTERY>SET.AA.TYPE.

The tables display the approximate hours and minutes remaining (h:mm).

Alkaline

Battery Indicator	RF Power Setting	
	10 mW	20 mW
	>11:00 to 9:35	5:45 to 5:15
	9:35 to 6:00	5:15 to 4:00
	6:00 to 2:30	4:00 to 2:00
	2:30 to 1:00	2:00 to 0:50
	1:00 to 0:20	0:50 to 0:10
	0:20 to 0:00	0:10 to 0:00

NiMH

Battery Indicator	RF Power Setting	
	10 mW	20 mW
	>13:00 to 11:10	9:00 to 7:40
	11:10 to 7:00	7:40 to 5:15
	7:00 to 2:50	5:15 to 2:05
	2:50 to 1:25	2:05 to 1:00
	1:25 to 0:20	1:00 to 0:15
	0:20 to 0:00	0:15 to 0:00

Shure SB900 Rechargeable Battery

When using an SB900 rechargeable battery, the receiver and transmitter home screens display the number of hours and minutes remaining.

Detailed information for the SB900 is displayed in the receiver BATTERY INFO menu and the transmitter menu: UTILITY>BATTERY>BATT. STATS

HEALTH: Displays battery health as a percentage of the charge capacity of a new battery.

CHARGE: Percentage of a full charge

CYCLES: Number of times the battery has been charged

TEMP: Battery temperature in Celsius and Fahrenheit

Note: For additional rechargeable battery information, visit www.shure.com.

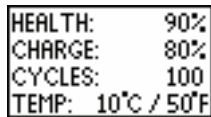

Shure SB900 Runtime

1 mW	10 mW	20 mW
>11 hours	>11 hours	>7 hour

Important Tips for Care and Storage of Shure Rechargeable Batteries

Proper care and storage of Shure batteries results in reliable performance and ensures a long lifetime.

- Always store batteries and transmitters at room temperature
- Ideally, batteries should be charged to approximately 40% of capacity for long-term storage
- During storage, check batteries every 6 months and recharge to 40% of capacity as needed

Installing the Battery Contact Cover

Install the included battery contact cover (65A15947) on the handheld transmitter to prevent light reflection in broadcast and performance situations.

1. Align the cover as shown.
2. Slide the cover over the battery contacts until it is flush with the transmitter body.

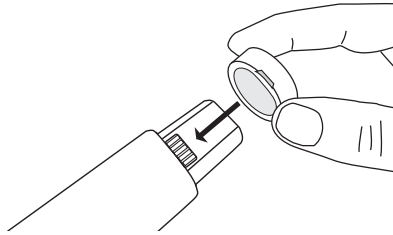

Note: Slide the cover off before inserting the transmitter in the battery charger.

Audio

Setting Receiver Gain

The receiver gain control sets the audio signal level for the entire receiver and transmitter system. Changes to the gain settings occur in realtime allowing for adjustments during live performances. When adjusting the gain, monitor the audio meter levels to prevent signal overloads.

Receiver Gain Controls

The gain can be adjusted by using the gain ▲▼ buttons or by entering the AUDIO menu and using the control wheel.

Tip: To quickly adjust the gain, press and hold a gain button to enable accelerated scrolling.

Reading the Audio Meter

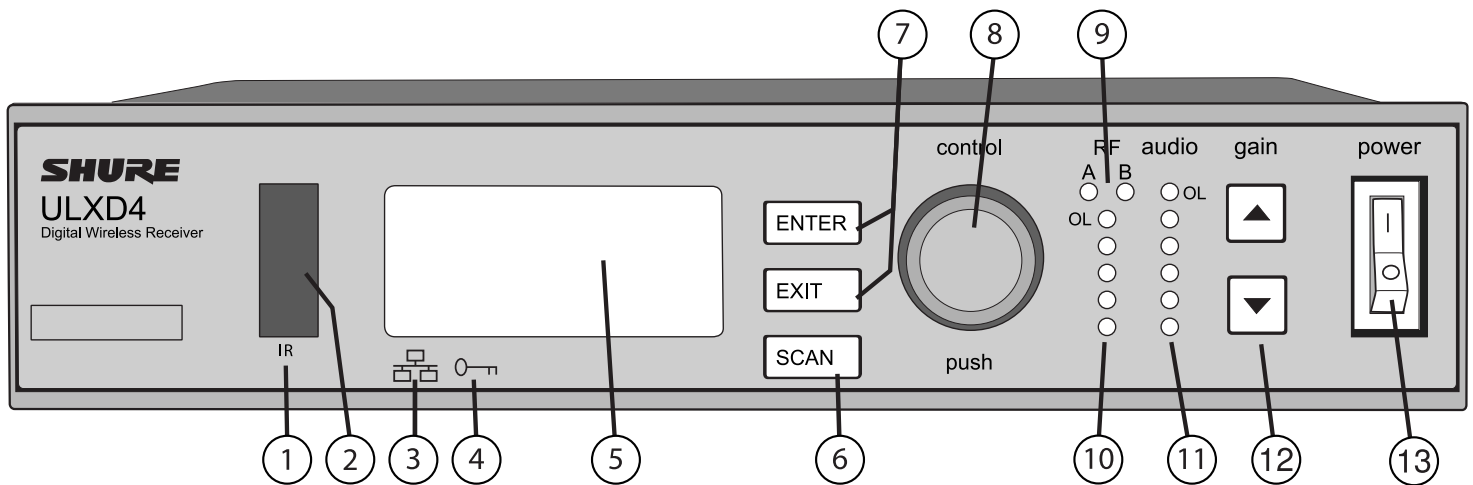

The audio meter displays yellow, green, and red LEDs to indicate the audio signal level. Audio peaks illuminate the LEDs for 2 seconds, while the RMS signal is displayed in realtime.

When setting up the receiver, adjust the gain so that the average signal LED levels are solid green and occasionally yellow, with only the highest peaks causing the red LED to illuminate.

Tip: If a vocalist is overloading a bodypack transmitter, try lowering the receiver gain. If additional attenuation is needed, use the transmitter menu to set the INPUT PAD to -12dB.

Note: Illumination of the red OL (overload) LED indicates the internal limiter is engaged to prevent digital clipping.

Muting a Receiver Channel Audio Output

The audio output of each receiver channel can be independently muted to prevent audio from passing. Mute status is indicated by Rx MUTED message appearing on the receiver display in place of the gain value.

Note: Receiver gain is disabled for muted channels to prevent unexpected changes in audio levels.

To set a receiver channel output to mute:

1. AUDIO >MUTE
2. Use the control wheel to select ON or OFF.
3. Press ENTER to save.

To unmute the receiver output:

Simultaneously press the ▲▼ buttons or select OFF from the MUTE menu option.

Tip: Audio mute can be enabled remotely from Wireless Workbench or from an external controller.

Important! A power cycle will reset the receiver and unmute the audio output.

Transmitter Input Clip

The following warning displays on the receiver LCD panel when the transmitter input is clipped:

To correct, attenuate the signal source. If the source cannot be attenuated while using a bodypack transmitter, select INPUT PAD from the main menu to attenuate the input signal 12 dB.

Audio Signal Encryption

When encryption is enabled, the receiver generates a unique encryption key which is shared with a the transmitter during an IR sync. Transmitters and receivers that share an encryption key form a protected audio path, preventing unauthorized access from other receivers.

Encrypting a Single Transmitter to a Single Receiver

1. From the receiver menu: DEVICE UTILITIES>ENCRYPTION> ON (Auto)
2. Press ENTER.
3. Perform an IR Sync to share the encryption key with the selected transmitter.

Encrypting Multiple Transmitters to a Single Receiver

Multiple transmitters can share the same encryption key, allowing them access to a single receiver. Use this method if you have multiple instruments or wish to use a combination of handheld and bodypack transmitters.

1. From the receiver menu: DEVICE UTILITIES>ENCRYPTION>ON (Manual)>KEEP KEYS.
2. Press ENTER.
3. Perform an IR Sync to share the encryption key with the first transmitter.
4. Turn off the transmitter and perform an IR Sync to share the key additional transmitters.

Caution! Make sure only one transmitter is turned on during an IR sync or a performance to avoid causing cross interference between transmitters.

Regenerating Encryption Keys

Periodically regenerating the encryption key maintains security for transmitters and receivers that are paired for extended periods.

1. From the receiver menu: DEVICE UTILITIES>ENCRYPTION>ON (Manual)>REGENERATE KEYS.
2. Press ENTER.
3. Perform an IR Sync to share the encryption key with the first transmitter.
4. Turn off the transmitter and perform an IR Sync to share the key additional transmitters.

Caution! Make sure only one transmitter is turned on during an IR sync or a performance to avoid causing cross interference between transmitters.

Removing Encryption

1. From the receiver menu: DEVICE UTILITIES ENCRYPTION OFF
2. Press ENTER.
3. IR Sync the transmitter and receiver to clear the encryption key.

Note: If multiple transmitters are encrypted to a single receiver, each transmitter must be IR synced to clear the encryption key.

Scan and Sync

Use this procedure to tune a receiver and transmitter to the best open channel.

Important! Before you begin:

Turn off all transmitters for the systems you are setting up. (This prevents them from interfering with the frequency scan.)

Turn on the following potential sources of interference so they are operating as they would be during the presentation or performance (the scan will detect and avoid any interference they generate).

- Other wireless systems or devices
 - Computers
 - CD players
 - Large LED panels
 - Effects processors
1. Press the SEL button to select a receiver channel.
 2. Perform a group scan on the receiver: SCAN>GROUP SCAN.
 3. Press SCAN to start the scan. SCANNING appears on the LCD during the scan.
 4. After the scan completes, the receiver displays the group with the most available frequencies. Press the flashing ENTER button to deploy frequencies to each receiver channel.
 5. Power on the ULXD transmitter.
 6. Press the sync button on the receiver.
 7. Align the IR windows until the receiver IR port illuminates red.

Note: When complete, SYNC SUCCESS! appears. The transmitter and receiver are now tuned to the same frequency.

Networked Receivers

1. Turn on all receivers.
 2. Conduct a group scan on the first receiver to find available frequencies in each group: SCAN>GROUP SCAN.
 3. Press ENTER to accept the group number and automatically assign the next best channel to each receiver on the network. The receiver LEDs will flash when a frequency has been assigned.
 4. Turn on a transmitter and sync to the receiver.
- Important!** Leave the transmitter on and repeat this step for each additional system.

Non-networked Receivers

1. Turn on all receivers.
2. Conduct a group scan on the first receiver to find available frequencies in each group: SCAN>SCAN>GROUP SCAN>SCAN
3. When the scan is complete, use the control wheel to scroll through each group. Press ENTER to select a group that has enough available frequencies for all channels in the system.
4. Sync a transmitter to each receiver channel.

Important! Leave all transmitters on use the following steps to set up additional receiver channels:

1. Set each additional receiver channel to the same group as the first receiver: RADIO>G:
2. Conduct a channel scan to find available frequencies within the group: SCAN>SCAN>CHANNEL SCAN>SCAN
3. When the scan is complete, press ENTER to assign frequencies to each receiver channel.
4. Sync a transmitter to each receiver channel.

Manual Frequency Selection

To manually adjust group, channel or frequency:

1. Select RADIO from the receiver menu.
2. Use the control wheel to select and adjust the group, channel, or frequency.
3. Press ENTER to save.

Transmitter IR Presets

Use the IR PRESETS receiver menu to quickly configure transmitter settings from the receiver screen. When a sync is performed between the receiver and transmitter, the IR PRESETS automatically configure the transmitter. Each parameter has the default value KEEP, which leaves that setting unaffected by a sync.

Feature	Setting
BP PAD	+0 dB, -12 dB
LOCK	Power, Menu, All, None
RF POWER	10mW=Nm (normal), 1mW=Lo (low), 20mW=Hi (high)
BATT	Alkaline, NiMH, Lithium
BP OFFSET	0 dB to +21 dB (in 3 dB increments)
HH OFFSET	0 dB to +21 dB (in 3 dB increments)
MUTE MODE	OFF, ON
Cust. Group	OFF, ON

Note: When Cust. Groups is set to on, it may take up to 30 seconds to complete an IR sync.

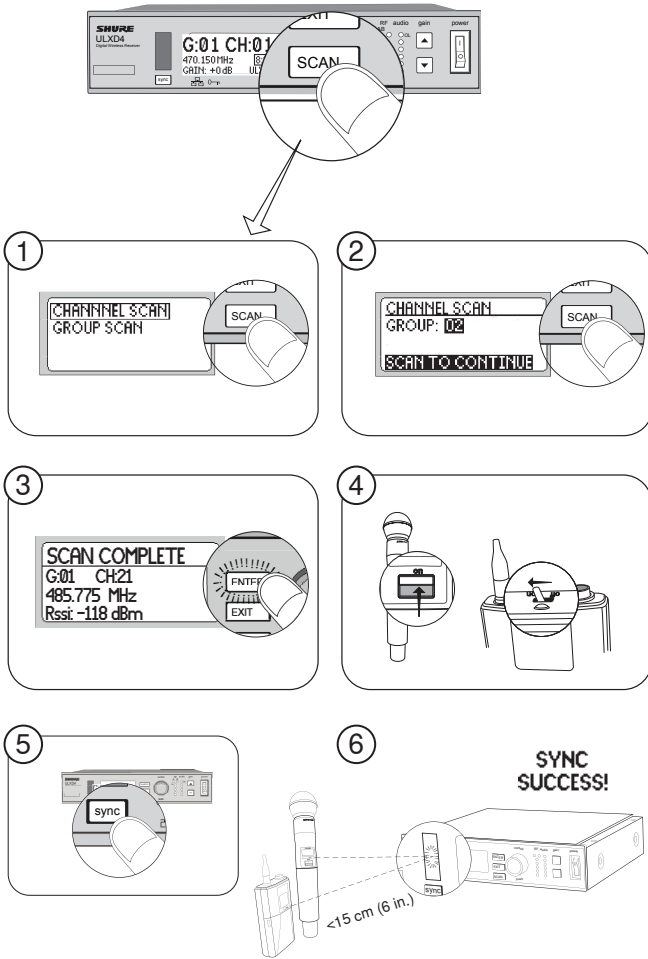

Multiple System Setup

A setup using networked receivers is the fastest and easiest way to distribute the best open channel to each system. See Networking ULX-D Receivers for networking details.

Note: Networked receivers must all be within the same frequency band.

Creating a System Preset

System Presets allow a current receiver setup to be saved and restored. Presets store all receiver settings to provide a quick way to configure a receiver or switch between several different setups. Up to 4 presets can be stored in receiver memory.

To save the current receiver setup as a new preset: DEVICE UTILITIES>SYSTEM RESET>SAVE>CREATE NEW PRESET

Use the control wheel to name the preset, and then press Enter to save.

To recall a saved preset: DEVICE UTILITIES>SYSTEM RESET>RESTORE

Use the control wheel to select the preset name, and then press Enter.

RF

Transmitter RF Power

Reference the following table for setting RF Power:

RF Power Setting	System Range	Application
1 mW	33 m (100 ft.)	For increased channel reuse at close distances
10 mW	100 m (330 ft.)	Typical setups
20 mW	>100 m (330 ft.)	For hostile RF environments or long-distance applications

Note: Using the 20 mW setting decreases the transmitter battery runtime and reduces the number of compatible systems.

Interference Detection

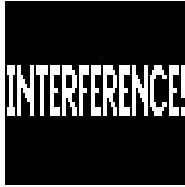

Interference Detection monitors the RF environment for potential sources of interference which can cause audio dropouts.

When interference is identified, the RF LEDs illuminate red and the following warning displays on the receiver LCD panel.

If the warning display persists or the audio drops out repeatedly, perform a Scan and Sync at the first opportunity to find a clear frequency.

Advanced RF

RF Mute



Use this to turn on a transmitter without interfering with the RF spectrum.

Press and hold the exit button during power-on until RF MUTED is displayed. To un-mute, restart the transmitter.

Custom Groups

Use this feature to create up to six groups of manually selected frequencies that can be exported to networked receivers to simplify system setup.

To create a custom group: UTILITES>ADVANCED RF>CUSTOM GROUPS

Note: Use Wireless Workbench or Wireless Frequency Finder to select the best compatible frequencies. See www.shure.com for more information.

To export a custom group:

1. Go to UTILITES>ADVANCED RF>CUSTOM GROUPS>EXPORT. The following screen will display.
2. Press the flashing ENTER button to export all custom groups to all receivers on the network.

Antenna Bias

Antenna ports A and B provide a DC bias to power active antennas. Set the DC power to off when using passive (non-powered) antennas.

To turn bias off: DEVICE UTILITIES>ADVANCED RF>ANTENNA BIAS>OFF

Networking Receivers

The receiver uses an Ethernet connection to network with other components. For automatic network configuration, use a DHCP enabled Ethernet switch such as the Shure AXT620. Use multiple Ethernet switches to extend the network for larger installations.

Note: Note use only one DHCP server per network.

Automatic IP Addressing

Set the IP Mode to Automatic for all receivers: DEVICE UTILITIES>NETWORK>CTRL NETWORK

Manual IP Addressing

1. Connect the receivers to an Ethernet switch.
2. Set the IP Mode to Manual for all devices (DEVICE UTILITIES>NETWORK>CTRL NETWORK)
3. Set valid IP addresses for all devices.
4. Set the subnet mask to the same value for all devices.

Troubleshooting

- Use only one DHCP server per network

- All devices must share the same subnet mask
- All receivers must have the same level of firmware revision installed
- Look for the illuminated network icon on the front panel of each device:
If the icon is not illuminated, check the cable connection and the LEDs on the network jack.
If the LEDs are not on and the cable is plugged in, replace the cable and recheck the LEDs and network icon.

To check connectivity of WWB6 to the network:

1. Start WWB6 software and use Inventory view to see devices connected to the network.
2. If not, find the IP address from one of the devices on the network (such as an ULXD receiver) and see if you can ping it from the computer running WWB6.
3. From a WINDOWS/MAC command prompt, type 'ping IPADDRESS' of the device (e.g. "ping 192.168.1.100").
4. If the ping returns success (no packet loss), then the computer can see the device on the network. If the ping returns failure (100% packet loss), then check the IP address of the computer to ensure it's on the same subnet as the Axient device.
5. If the pings are successful and the devices still do not show up in the WWB6 inventory, check to ensure all firewalls are either disabled or allow the WWB network traffic to pass to the application. Check that firewall settings are not blocking network access.

Device ID

Set the receiver Device ID for easy identification within the network or in Wireless Workbench: DEVICE UTILITIES>NETWORK>SHURE CONTROL>Dev.ID

Use the control wheel to edit the device ID.

High Density Mode

High Density mode creates additional bandwidth for more channels in crowded RF environments. Frequency efficiency is optimized by running at

1 mW RF transmit power and narrowing the modulation bandwidth, allowing for the channel spacing to be reduced from 350 kHz to 125 kHz. Transmitters can be positioned on adjacent channels with unsubstantial intermodulation distortion (IMD).

High Density mode is ideal for applications where many channels are needed in a confined area, transmission distances are short, and the number of available frequencies is limited. Up to 30 meters of range is available in High Density mode.

Setting the Receiver to High Density Mode

To set the receiver to High Density mode:

DEVICE UTILITIES>ADVANCED RF>HIGH DENSITY

Use the control wheel to set HIGH DENSITY to ON.

When prompted, sync the transmitter and receiver to enable HIGH DENSITY mode.

Note: When the receiver is in HIGH DENSITY mode, the following indicators are shown on the receiver display:

- The HD icon will appear on the receiver display
- The receiver band name will be shown with an "HD" added. (example: The G50 band will appear as G50HD)
- The transmitter group and channel are assigned letters instead of numbers (example: G:AA CH:AA)

Best Practices for High Density Mode

- When band planning, position ULX-D High Density channels in a range of frequencies separated from other devices.
- Use a separate RF zone for ULX-D High Density channels to prevent intermodulation distortion from other devices.
- During High Density channel scanning, turn on all other transmitters and move them to their intended position.
- Perform a walk test to verify transmitter range
- If using custom groups, the groups loaded into the receiver must be compatible with High Density mode

System Reset

System Reset clears the current receiver settings and restores the factory default settings.

To restore factory default settings:

1. Go to DEVICE UTILITIES>SYSTEM RESET>RESTORE.
2. Scroll to the DEFAULT SETTINGS option and press ENTER.
3. Press the flashing ENTER button to return the receiver to the default settings.

Firmware

Firmware is embedded software in each component that controls functionality. Periodically, new versions of firmware are developed to incorporate additional features and enhancements. To take advantage of design improvements, new versions of the firmware can be uploaded and installed using the Firmware Update Manager tool available in Shure's Wireless Workbench® 6 (WWB6) software. Software is available for download from <http://www.shure.com/wwb>.

Firmware Versioning

When updating receiver firmware, update transmitters to the same firmware version to ensure consistent operation.

The firmware of all ULX-D devices has the form of MAJOR.MINOR.PATCH (e.g., 1.2.14). At a minimum, all ULX-D devices on the network (including transmitters), must have the same MAJOR and MINOR firmware version numbers (e.g., 1.2.x).

Updating the Receiver

CAUTION! Ensure that receiver power and network connections are maintained during a firmware update. Do not turn off the receiver until the update is complete.

Once the download is complete, the receiver automatically begins the firmware update, which overwrites the existing firmware.

1. From Shure Wireless Workbench software, open the Firmware Update Manager: Tools>Firmware Update Manager.
2. Click Check Now to view new versions available for download.
3. Select the updates and click download.
4. Connect the receiver and computer to the same network.
5. Download the latest firmware to the receiver.

Updating the Transmitter

1. To upload the firmware to the transmitter, go to DEVICE UTILITIES>TX FW UPDATE on the receiver.

2. Place the transmitter on its side and align the IR ports.
3. Press ENTER on the receiver to begin the download to the transmitter. IR ports must be aligned for the entire download, which can take 50 seconds or longer.

Managing the ULXD Receiver with Wireless Workbench 6

Adding a computer running Wireless Workbench® 6 to the network allows for remote control and monitoring of the receiver.

Visit: www.shure.com/wwb to download Wireless Workbench 6 software.

Managing and Monitoring Receiver Settings

Manage and monitor receiver settings by opening the Monitor tab in Wireless Workbench. Click on the Settings button to show or hide the full Properties window.

1. Click on the Monitor tab to view the Device Chooser.
2. From the Device Chooser, click on a channel to select.
3. Click on Properties to open the Properties window.

① RF and Audio Meters

Displays: current levels, band, TV, and TX Overload

② Transmitter Settings

Displays: RF Power, Tx Type, Tx Offset, Tx Lock

③ Frequency Settings

Use drop-down to edit value

④ Encryption Icon

Illuminates when Encryption is enabled

⑤ Receiver Output Mute

Click on the mute button to enable mute

⑥ Receiver Gain Setting

Use drop-down to edit value

⑦ Custom Groups

Click to enter custom group settings

⑧ IR Presets

Click to configure transmitter IR presets

⑨ Utilities Tab

Accesses Utility settings

⑩ Network Tab

Set network mode, view: IP address, Subnet, MAC, Firmware version

⑪ Advanced RF Settings

Enable High Density mode or Antenna Bias

⑫ Encryption

Enable/Disable Encryption

⑬ Locks

Lock/Unlock: Menu, Gain, Power, Scan/Sync

Viewing the Receiver in WWB6 Inventory

Click on the Inventory tab to view the receiver channels. Double-click on parameters to enable editing.

Tip: Clicking on the receiver Icon next to the Model flashes the front panel LEDs for remote identification.

Hardware Identify

Hardware Identify is a useful feature for remotely discovering and identifying networked components that appear in WWB6 inventory. For example, individual receivers located on a stage can be identified remotely in the WWB6 inventory window by pressing the control wheel on the receiver. When the control wheel is pressed, the corresponding receiver icon in WWB6 will flash to identify the location of the receiver.

Troubleshooting

Issue	See Solution...
No Sound	Power, Cables, or RF
Faint sound or distortion	Gain
Lack of range, unwanted noise bursts, or dropouts	RF
Cannot turn transmitter off or change frequency settings, or can't program receiver	Interface locks
Encryption error message	Encryption Mismatch

Power

Make sure that the receiver and transmitter are receiving sufficient voltage. Use the 15 V DC power supply furnished with the ULXD4 receiver. Check the battery indicators and replace the transmitter batteries if necessary.

Gain

Adjust the system gain on the front of the receiver. Ensure the output level (XLR output only) on the back of the receiver corresponds to the input of the mixing console, amplifier, or DSP.

Cables

Check that all cables and connectors are working correctly.

Interface Locks

The transmitter and the receiver can be locked to prevent accidental or unauthorized changes. A locked feature or button will produce the Locked screen on the LCD panel.

Encryption Mismatch

Re-sync the receiver and transmitter after enabling or disabling encryption.

Radio Frequency (RF)

RF LEDs

If neither blue RF Diversity LED is illuminated, then the receiver is not detecting the presence of a transmitter.

The amber RF Signal Strength LEDs indicate the amount of signal being received. This signal could be from the transmitter, **or it could be from an interfering source, such as a television broadcast.** If more than one or two of the amber RF LEDs are still illuminated while the transmitter is off, then that channel has too much interference, and you should try a different channel.

The red RF LED indicates RF overload. This will usually not cause a problem unless you are using more than one system at the same time, in which case, it can cause interference **in the other system.**

Compatibility

- Perform a Scan and Sync to ensure the transmitter and receiver are set to the same group and channel.
- Look at the label on the transmitter and receiver to make sure they are in the same band (G50, J50, L50, etc...).

Reducing Interference

- Perform a group or channel scan to find the best open frequency. Perform a sync to transfer the setting to the transmitter.

- For multiple systems, check that all systems are set to channels in the same group (systems in different bands do not need to be set to the same group).
- Maintain a line of sight between transmitter and receiver antennas.
- Move receiver antennas away from metal objects or other sources of RF interference (such as CD players, computers, digital effects, network switches, network cables and Personal Stereo Monitor (PSM) wireless systems).
- Eliminate RF overload (see below).

Increasing Range

If the transmitter is more than 6 to 60 m (20 to 200 ft) from the receiver antenna, you may be able to increase range by doing one of the following:

- Reduce interference (see above).
- Increase transmitter RF power level.
- Use an active directional antenna, antenna distribution system, or other antenna accessory to increase RF range.

Eliminating RF Overload

If you see the red RF LED on a receiver, try the following:

- Reduce the transmitter RF power level
- Move the transmitter further away from the receiver—at least 6 m (20 ft)
- If you are using active antennas, reduce antenna or amplifier gain.
- Use omnidirectional antennas

Certifications

ULXD1, ULXD2, ULXD4

Meets essential requirements of the following European Directives:

- WEEE Directive 2002/96/EC, as amended by 2008/34/EC
 - RoHS Directive 2011/65/EU
- Note:** Please follow your regional recycling scheme for batteries and electronic waste

Hereby, Shure Incorporated declares that the radio equipment is in compliance with Directive 2014/53/EU. The full text of the EU declaration of conformity is available at the following internet address: <http://www.shure.com/europe/compliance>

Authorized European representative:
Shure Europe GmbH
Headquarters Europe, Middle East & Africa
Department: EMEA Approval
Jakob-Dieffenbacher-Str. 12
75031 Eppingen, Germany
Phone: +49-7262-92 49 0
Fax: +49-7262-92 49 11 4
Email: EMEAsupport@shure.de

ULXD1, ULXD2

Certified under FCC Part 74.

Certified by IC in Canada under RSS-102 and RSS-210.

IC: 616A-ULXD1 G50, 616A-ULXD1 H50, 616A-ULXD1 J50, 616A-ULXD1 L50; 616A-ULXD2 G50, 616A-ULXD2 H50, 616A-ULXD2 J50, 616A-ULXD2 L50.

FCC: DD4ULXD1G50, DD4ULXD1H50, DD4ULXD1J50, DD4ULXD1L50; DD4ULXD2G50, DD4ULXD2H50, DD4ULXD2J50, DD4ULXD2L50.

IC: 616A-ULXD1X52, 616A-ULXD2X52

FCC: DD4ULXD1X52, DD4ULXD2X52

IC: 616A-ULXD1V50, 616A-ULXD2V50

FCC: DD4ULXD1V50, DD4ULXD2V50

Note: For transmitters operating in the V50 and V51 bands: nominal free space antenna gain at middle of the band is typically -6 dBi, and rolls off at the band edges an additional -4 dB.

ULXD4

Approved under the Declaration of Conformity (DoC) provision of FCC Part 15.

Conforms to electrical safety requirements based on IEC 60065.

Specifications

ULXD Specifications

RF Carrier Frequency Range

470–814 MHz, varies by region (See Frequency Range and Output Power table)

Working Range

100 m (330 ft)

0

RF Tuning Step Size

25 kHz, varies by region

Image Rejection

>70 dB, typical

RF Sensitivity-98 dBm at 10⁻⁵ BER**Latency**

<2.9 ms

Audio Frequency Response

ULXD1	20 – 20 kHz (±1 dB)
ULXD2	Note: Dependent on microphone type

Audio Dynamic Range

System Gain @ +10

>120 dB, A-weighted, typical

Total Harmonic Distortion

-12 dBFS input, System Gain @ +10

<0.1%

System Audio Polarity

Positive pressure on microphone diaphragm produces positive voltage on pin 2 (with respect to pin 3 of XLR output) and the tip of the 6.35 mm (1/4-inch) output.

Operating Temperature Range

-18°C (0°F) to 50°C (122°F)

1

Storage Temperature Range

-29°C (-20°F) to 74°C (165°F)

2

Receiver Output Level

The following table describes the typical total system gain from the audio input to the receiver outputs:

Output Jack	System Gain (gain control = 0dB)
1/4" TRS	+18 dB
XLR (line setting)	+24 dB
XLR (mic setting)	-6 dB*

*This setting matches a typical wired SM58 audio signal level.

⁰ Note: Actual range depends on RF signal absorption, reflection and interference.¹ Note: Battery characteristics may limit this range.² Note: Battery characteristics may limit this range.

Tables and Diagrams

TA4M Connector

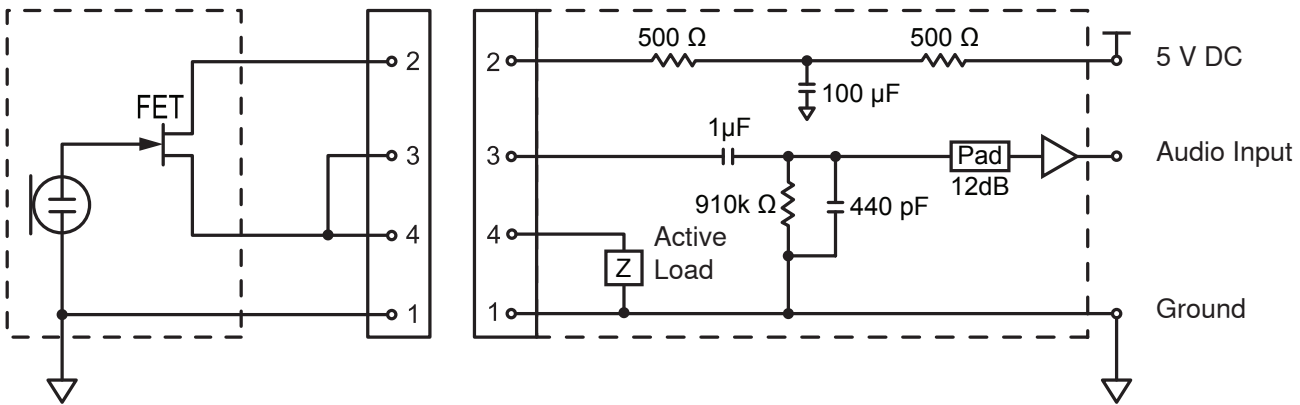

LEMO Connector

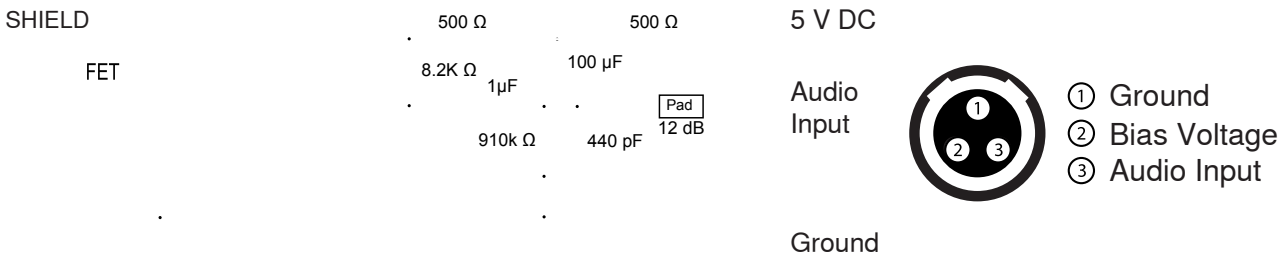

XLR to 1/4 Output

Use the following wiring diagram to convert the XLR output to a 1/4 output.

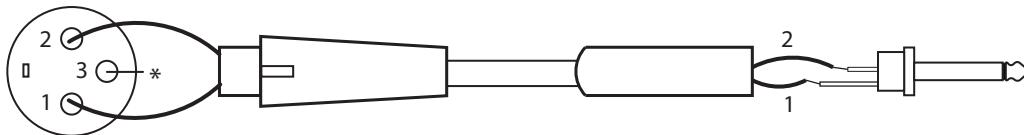

* No Connection

Batteries

ULXD	SB900A		alkaline	
	1/10 mW	20 mW	1/10 mW	20 mW
470 to 810	>11 hours	>7 hours	11 hours	5:30 hours
902 to 928	10 hours	>7 hours	>9 hours	6 hours
174 to 216	>9 hours	7 hours	8 hours	>5 hours
1240 to 1800	>8:30 hours	>6:30 hours	>6 hours	>4:30 hours

The values in this table are typical of fresh, high quality batteries. Battery runtime varies depending on the manufacturer and age of the battery.

Frequency Range and Transmitter Output Power

Band	Frequency Range (MHz)	Power (mW RMS)*
		(Lo/Nm/Hi)
G50	470 to 534	1/10/20
G51	470 to 534	1/10/20
G52	479 to 534	1/10
G62	510 to 530	1/10/20
H50	534 to 598	1/10/20
H51	534 to 598	1/10/20
H52	534 to 565	1/10
J50	572 to 636	1/10/20
J51	572 to 636	1/10/20
K51	606 to 670	1/10
L50	632 to 696	1/10/20
L51	632 to 696	1/10/20
L53	632 to 714	1/10/20
P51	710 to 782	1/10/20
R51	800 to 810	1/10/20
JB (Tx only)	806 to 810	1/10
AB (Rx and Tx)	770 to 810	'A' Band (770-805): 1/10/20
		'B' Band (806-809): 1/10
Q51	794 to 806	1/10/20
V50	174 to 216	1/10/20
V51	174 to 216	1/10/20
X50	925 to 932	1/10
X51	925 to 937.5	10
X52	902 to 928	0.25/10/20
X53	902 to 907.500, 915 to 928	0.25/10/20
X54	915 to 928	0.25/10/20
Z16	1240 to 1260	1/10/20
Z17	1492 to 1525	1/10/20
Z18	1785 to 1805	1/10/20
Z19	1785 to 1800	1/10/20
Z20	1790 to 1805	1/10/20

Note: Frequency bands might not be available for sale or authorized for use in all countries or regions.

3

For the band Z17 (1492-1525 MHz), it must be used indoors only.

For the Band Z19 (1785-1800MHz) used in Australia, per Radio Communications Low Interference Potential Devices Class License 2015; item 30 note C: the system must be operated within the range of 1790-1800MHz when used outdoors.

低功率電波輻射性電機管理辦法

第十二條

³ * Power delivered to the antenna port

經型式認證合格之低功率射頻電機，非經許可，公司、商號或使用者均不得擅自變更頻率、加大功率或變更原設計之特性及功能。第十四條

低功率射頻電機之使用不得影響飛航安全及干擾合法通信；經發現有干擾現象時，應立即停用，並改善至無干擾時方得繼續使用。前項合法通信，指依電信法規定作業之無線電通信。低功率射頻電機須忍受合法通信或工業、科學及醫療用電波輻射性電機設備之干擾。

Frequencies for European Countries

Country Code	Frequency Range
Code de Pays	Gamme de frequences
Codice di paese	Gamme di frequenza
Código de país	Gama de frecuencias
Länder-Kürzel	Frequenzbereich
A, B, BG, CH, CY, CZ, D, DK, EST, F	*
FIN, GB, GR, H, HR, I, IRL, IS, L, LT	*
M, N, NL, P, PL, RO, S, SK, SLO, TR	*
All other countries	*

* This equipment may be capable of operating on some frequencies not authorized in your region. See Licensing Information.

Country Code	Frequency Range
Code de Pays	Gamme de frequences
Codice di paese	Gamme di frequenza
Código de país	Gama de frecuencias
Länder-Kürzel	Frequenzbereich
A, B, BG, CH, CY, CZ, D, EST	534 - 598 MHz*
F, GB, GR, H, I, IS, L, LT	534 - 598 MHz*
NL, P, PL, S, SK, SLO	534 - 598 MHz*
DK, FIN, M, N	*
HR, E, IRL, LV, RO, TR	*
All other countries	*

* This equipment may be capable of operating on some frequencies not authorized in your region. See Licensing Information.

Country Code	Frequency Range
Code de Pays	Gamme de frequences
Codice di paese	Gamme di frequenza
Código de país	Gama de frecuencias
Länder-Kürzel	Frequenzbereich
A, B, BG, CH, CY, CZ, D, EST	606 - 670 MHz*
F, GB, GR, H, I, IS, L, LT	606 - 670 MHz*
NL, P, PL, S, SK, SLO	606 - 670 MHz*
RO	646 - 647; 654 - 655; 662 - 663 MHz*
DK, E, FIN, HR, IRL, LV, M, N, TR	*
All other countries	*

* This equipment may be capable of operating on some frequencies not authorized in your region. See Licensing Information.

Country Code	Frequency Range
Code de Pays	Gamme de frequences
Codice di paese	Gamme di frequenza
Código de país	Gama de frecuencias
Länder-Kürzel	Frequenzbereich
A, B, BG, CH, CY, CZ, D, DK, EST, F	*
FIN, GB, GR, H, HR, I, IRL, IS, L, LT	*
M, N, NL, P, PL, RO, S, SK, SLO, TR	*
All other countries	*

* This equipment may be capable of operating on some frequencies not authorized in your region. See Licensing Information.

Country Code	Frequency Range
Code de Pays	Gamme de frequences
Codice di paese	Gamme di frequenza
Código de país	Gama de frecuencias
Länder-Kürzel	Frequenzbereich
A, B, BG, CH, CY, CZ, D, EST, F, GB	710 - 782 MHz*
GR, H, I, IS, L, LT, NL, P, PL, S, SK, SLO	710 - 782 MHz*
RO	718 - 719; 726 - 727; 734 - 743; 750 - 751; 758 - 759 MHz*
DK, E, FIN, HR, IRL, LV, M, N, TR	*
All other countries	*

* This equipment may be capable of operating on some frequencies not authorized in your region. See Licensing Information.

Country Code	Frequency Range
Code de Pays	Gamme de frequences
Codice di paese	Gamme di frequenza
Código de país	Gama de frecuencias
Länder-Kürzel	Frequenzbereich
A, B, BG, CH, CY, CZ, D, DK, E, EST	*
F, FIN, GB, GR, H, HR, I, IRL, IS, L, LT	*
LV, M, N, NL, P, PL, S, SK, SLO, TR	*
All other countries	*

* This equipment may be capable of operating on some frequencies not authorized in your region. See Licensing Information.

Country Code	Frequency Range
Code de Pays	Gamme de frequences
Codice di paese	Gamme di frequenza
Código de país	Gama de frecuencias
Länder-Kürzel	Frequenzbereich
N	800 - 810 MHz*
A, B, BG, CH, CY, CZ, D, DK, E, EST	*
F, FIN, GB, GR, H, HR, I, IRL, IS, L, LT	*
LV, M, N, NL, P, PL, S, SK, SLO, TR	*
All other countries	*

* This equipment may be capable of operating on some frequencies not authorized in your region. See Licensing Information.

Country Code	Frequency Range
Code de Pays	Gamme de frequences
Codice di paese	Gamme di frequenza
Código de país	Gama de frecuencias
Länder-Kürzel	Frequenzbereich
D	license free
A, B, BG, CH, CY, CZ, D, DK, EST, F	*
FIN, GB, GR, H, HR, I, IRL, IS, L, LT	*
M, N, NL, P, PL, RO, S, SK, SLO, TR	*
863 - 865 MHz	EU: license free
All other countries	*

* This equipment may be capable of operating on some frequencies not authorized in your region. See Licensing Information.

Country Code	Frequency Range
Code de Pays	Gamme de frequences
Codice di paese	Gamme di frequenza
Código de país	Gama de frecuencias
Länder-Kürzel	Frequenzbereich
A, B, BG, CH, CY, CZ, D, DK, E, EST	*
F, FIN, GB, GR, H, HR, I, IRL, IS, L, LT	*
LV, M, N, NL, P, PL, S, SK, SLO, TR	*
All other countries	*

* This equipment may be capable of operating on some frequencies not authorized in your region. See Licensing Information.

Country Code	Frequency Range
Code de Pays	Gamme de frequences
Codice di paese	Gamme di frequenza
Código de país	Gama de frecuencias
Länder-Kürzel	Frequenzbereich
A, B, BG, CH, CY, CZ, D, DK, E, EST	*
F, FIN, GB, GR, H, HR, I, IRL, IS, L, LT	*
LV, M, N, NL, P, PL, S, SK, SLO, TR	*
This Wireless microphone operates on the range of 1492-1525 MHz. Should be used INDOORS ONLY.	
All other countries	*

* This equipment may be capable of operating on some frequencies not authorized in your region. See Licensing Information.

Country Code	Frequency Range
Code de Pays	Gamme de frequences
Codice di paese	Gamme di frequenza
Código de país	Gama de frecuencias
Länder-Kürzel	Frequenzbereich
A, B, BG, CH, CY, CZ, D, DK, E, EST	*
F, FIN, GB, GR, H, HR, I, IRL, IS, L, LT	*
LV, M, N, NL, P, PL, S, SK, SLO, TR	*
All other countries	*

* This equipment may be capable of operating on some frequencies not authorized in your region. See Licensing Information.

Accessories

Furnished Accessories

All Systems

Receiver	ULXD4
Power Supply	PS43
1/2 Wave Antenna (2)	95T9279
2' BNC Cable (2)	95K2035
BNC Bulkhead Adapters (2)	95A8994
Rackmount Kit (1)	90AZ8100
Shielded Ethernet Cat5e Cable (1)	95B15103
AA Alkaline batteries (2)	80B8201

Handheld Systems

Handheld Transmitter	ULXD2
Cartridge	see options below
Microphone Clip	95T9279
Zipper Bag	95B2313

Choice of one (1) of the following:

SM58	RPW112
SM86	RPW114
SM87A	RPW116
Beta 58A	RPW118
Beta 87A	RPW120
Beta 87C	RPW122
KSM9	RPW184
KSM9HS	RPW186

Bodypack System

Bodypack Transmitter	ULXD1
Antenna	95G9043
Zipper Bag	95A2313

Choice of one (1) of the following:

Instrument cable	WA302
Instrument Clip-on microphone	Beta 98H/C
Lavalier microphone	MX150, MX153, WL183, WL184, WL185

Antennas

Band	1/2-Wave Receiver Antennas	1/4-Wave Transmitter Antennas
G50	95AA9279	95G9043 (Yellow)
G51	95AA9279	95G9043 (Yellow)
G52	95AA9279	95G9043 (Yellow)
H51	95AL9279	95D9043 (Gray)
H52	95AL9279	95D9043 (Gray)
J50	95AK9279	95E9043 (Black)
K51	95AJ9279	95E9043 (Black)
L50	95AD9279	95E9043 (Black)

L51	95AD9279	95E9043 (Black)
P51	95AF9279	95F9043 (Blue)
R51	95M9279	95F9043 (Blue)
AB	95M9279	N/A
Q51	95M9279	N/A

Optional Accessories

Shure Rechargeable Battery	SB900
8-Bay Battery Charger	SBC800
Dual Docking Battery Charger	SBC200
Boundary Transmitter	ULXD6
Gooseneck Base Transmitter	ULXD8
4-Bay Networked Charger for ULXD6 and ULXD8 Transmitters	SBC450
8-Bay Networked Charger for ULXD6 and ULXD8 Transmitters	SBC850
Carrying Case	WA610
Y-Cable for Bodypack Transmitters	AXT652
Active Antenna Splitter	UA845SWB
Passive Antenna Splitter/Combiner Kit	UA221
UHF Line Amplifier	UA830USTV
UHF Antenna Power Distribution Amplifier (U.S.A.)	UA844SWB
UHF Antenna Power Distribution Amplifier (Europe)	UA844SE
In-line Power Supply	UABIAST
Front Mount Antenna Kit (Includes 2 cables and 2 bulkhead)	UA600
Remote Antenna Bracket with BNC Bulkhead Adapter	UA505
UHF Powered Directional Antenna	UA874WB
Passive Directional Antenna	PA805SWB
Coaxial Cable, BNC-BNC, RG58C/U type, 50 Ohm, 2 ft length (0.6 m)	UA802
Coaxial Cable, BNC-BNC, RG58C/U type, 50 Ohm, 6 ft length (2 m)	UA806
Coaxial Cable, BNC-BNC, RG8X/U type, 50 Ohm, 25 ft length (7.5 m)	UA825
Coaxial Cable, BNC-BNC, RG8X/U type, 50 Ohm, 50 ft length (15 m)	UA850
Coaxial Cable, BNC-BNC, RG213/U Type, 50 Ohm, 100 ft length (30 m)	UA8100
Rackmount Bracket, Short	53A8611
Rackmount Bracket, Long	53A8612
Link Bar	53B8443
Single Rack Mount Kit	RPW503
Dual Rack Mount Kit	RPW504

Black Bodypack Pouch	WA582B
----------------------	--------